

## Antriebssysteme

Installation and Maintenance instruction  
for drive unit Typ MD400

(Translation from the German original)

## Inhalt

<b>1.</b>	<b>Use of the documentation</b>	<b>4</b>
1.1	Change Index	4
1.2	Structure of the safety notes	4
1.3	Structure of safety instructions	5
1.4	Explanation of hazard symbols	5
1.5	EC Machinery Directive	5
1.6	Risk analysis	5
1.7	Modifications/conversions	5
1.8	Technical changes	5
1.9	Disclaimer	5
1.10	Description, designation	5
<b>2.</b>	<b>Safety</b>	<b>6</b>
2.1	Operating ranges	6
2.2	Reasonably foreseeable misuse	6
2.3	Personnel requirements	7
2.4	Compliance with the assembly instructions	7
2.5	Residual risks and protective measures	8
<b>3.</b>	<b>Technical data</b>	<b>9</b>
3.1	Short description	9
3.2	Labelling	10
<b>4.</b>	<b>Delivery, internal transport, unpacking</b>	<b>11</b>
4.1	Storage	11
4.2	Unpacking	11
<b>5.</b>	<b>Assembly and installation</b>	<b>12</b>
5.1	Assembly preparation	12
5.2	Mounting the drive unit	12
5.3	Power supply drive unit	13
5.4	Connecting the electrical interface	13
5.5	Connecting the battery	13
5.6	Mechanical fastening	14
5.7	Electrical connection	14
<b>6.</b>	<b>Start-up</b>	<b>14</b>
6.1	Checking the installation	14
6.2	Mounting accessories	14
6.3	General	14
6.4	Factory settings	15
6.5	Menu and messages on the display	15
6.6	Program structure	16
6.7	Legend for display for variant B and V	17
6.8	Switching ON	18
6.9	Switching OFF	18
6.10	Checking and changing settings	19
6.11	Info menu	19
6.12	Settings menu	20
6.12.1	Setting menu -Hour mode-	21
6.12.2	Setting menu -Emptying time mode-	21
6.12.3	Setting menu -Pulse mode-	22
6.13	Quick Check menu	22
6.14	Filling menu	22

<b>7.</b>	<b>Control of input and output signals</b>	<b>23</b>
7.1	Output signals in hour -h- or emptying mode -Et-.	23
7.2	Control in pulse mode (PUL)	23
7.3	Control signals	24
7.3.1	2 seconds control signal	25
7.3.2	5 seconds control signal	26
7.3.3	8 seconds control signal	27
7.3.4	12 seconds control signal	28
7.3.5	14 seconds control signal	29
<b>8.</b>	<b>Error messages (troubleshooting)</b>	<b>30</b>
8.1	Error messages	30
8.1.1	Error E1 (empty signal)	31
8.1.2	Error E2 (overload)	32
8.1.3	Error E3 (undervoltage)	32
8.1.4	Error E4 (serious error)	32
<b>9.</b>	<b>Maintenance</b>	<b>33</b>
9.1	Maintenance intervals	33
9.2	Cleaning	33
<b>10.</b>	<b>Replacing lubricant cartridge and battery</b>	<b>34</b>
<b>11.</b>	<b>Repair</b>	<b>34</b>
<b>12.</b>	<b>Disposal</b>	<b>34</b>
<b>13.</b>	<b>Variants</b>	<b>35</b>
<b>14.</b>	<b>Declaration of incorporation</b>	<b>36</b>

Important basic information

**1. Use of the documentation**

**Before commissioning the drive unit for the lubricator type MD400-B / type MD400-V / MD400-D, please read these commissioning and maintenance instructions carefully and follow the instructions. carefully and observe the instructions.**

The installation and maintenance instructions explain the operation in detail and give necessary instructions for handling, maintenance, and care. This manual may also describe versions that are not part of the equipment of your system. Warranty claims cannot be accepted for damage resulting from operating errors or improper use. It must be ensured that the persons responsible for the system and its operation, as well as persons who work independently on the product, have read, and understood this documentation in full. If you have any questions or require further information, please contact us.





**1.1 Change Index**

Index	Date	short sign	change
2	14.07.21	Wes	section5.2
3	31.03.23	Wes	Change Display

**1.2 Structure of the safety notes**

Symbols and signal words





The following table shows the grading and significance of the signal words of the warnings

symbol / signal word	meaning
	Point out the handling and impact of safety information.
 <b>DANGER</b>	Draws attention to an imminent threat that will result in a fatal injury or death if not avoided.
 <b>WARNING</b>	Draws attention to a dangerous situation that can result in a fatal injury or death if not avoided.
 <b>CAUTION</b>	Draws attention to a dangerous situation that can cause a mild to moderate injury if not avoided
<b>NOTICE</b>	Draws your attention to possible damage to property and other important information.

### 1.3 Structure of safety instructions

	symbol / signal word
	type of hazard Possible damage if you disregard the proof of safety ■ Measure(s) to avert the hazard

### 1.4 Explanation of hazard symbols

Gefahrensymbol	Bedeutung
	General Hazardous Area
	Flammable substances
	Warning of electrical voltage
	Environmental pollution warning

### 1.5 EC Machinery Directive

Within the scope of application of the EC/EU directive, the drive unit for lubricators Type MD400-B / Type MD400-V / MD400-D is an incomplete machine, therefore the (re-)commissioning of a machine on which the drive unit for lubricators Type MD400-B / Type MD400-V / MD400-D has been installed and/or mounted is prohibited until it has been clearly established that the machine complies with the provisions of the applicable directive.

### 1.6 Risk analysis

We strongly recommend that you carry out an analysis of all risks associated with the entire machine or installation after the project development and at the latest after the installation of the gearbox.

### 1.7 Modifications/conversions

Any mechanical machining on the unit or parts of the unit is not permissible unless expressly approved in writing by ATLANTA Antriebssysteme GmbH.

### 1.8 Technical changes

ATLANTA Antriebssysteme GmbH reserves the right to make technical changes to improve the product.

### 1.9 Disclaimer

The manufacturer will not assume any liability for damage or injuries resulting from improper use of the unit. Any improper manipulations and other acts not in accordance with these instructions will affect the product's quality. This will lead to the loss of warranty claim for material defects against the company ATLANTA Antriebssysteme GmbH

### 1.10 Description, designation

The ATLANTA drive unit for lubricators type MD400-B / type MD400-V / MD400-D will be referred to as drive unit in the following.

## 2. Safety

<b>NOTICE</b>	<p>The drive unit in conjunction with the lubricant cartridge may only be used for relubrication in industrial use under atmospheric conditions.</p> <p>The operating conditions and limits under which the drive unit may be operated can be found in the chapter "Areas of application and technical data".</p> <p>Only lubricants approved by ATLANTA Antriebssysteme E. Seidenspinner GmbH &amp; Co. KG may be used.</p>
---------------	--

<b>NOTICE</b>	<p>Operation outside of these specified general conditions is considered improper use and is prohibited.</p> <p>Operation of the drive unit is prohibited if:</p> <ul style="list-style-type: none"><li>• Installation is not carried out properly (e.g. fastening)</li><li>• The power supply is not properly connected</li><li>• it is not used for its intended purpose</li><li>• it is exposed to vibrations</li><li>• it is operated with non-approved lubricant or without lubricant</li></ul>
---------------	--

### 2.1 Operating ranges

- The operating temperature range of the drive unit is from -15°C to +60°C. If operation is to take place outside this range, consultation with ATLANTA Antriebssysteme E. Seidenspinner GmbH & Co. KG is absolutely necessary.
- The drive unit must not be used in the following ambient conditions:
  - Explosive atmosphere
  - Gases / vapours (hot / cold)
  - Oils, oil mist
  - Solvents, acids, alkalis
  - Radiation
  - UV radiation
  - electrostatic discharge (ESD)
  - Humidity >60

### 2.2 Reasonably foreseeable misuse

Any use outside the permissible ambient conditions and technical data (see application areas and technical data) as well as disassembly or modification of the drive unit is prohibited.

## 2.3 Personnel requirements

### General risk

The unit presents unavoidable residual risks to persons and property. For this reason, only skilled and trained personnel who are aware of the possible risks may carry out assembly, installation, commissioning and servicing work. All work may only be carried out by individuals who have a reliable understanding of the safety-related aspects based on their specialist knowledge gained from their professional training, professional experience and recent professional activities.

Qualified personnel must have current knowledge of the technology involved in the tasks to be performed and the hazards to be monitored as well as have the qualifications required for the activity to be done and be familiar with the assembly, installation, commissioning and operation of the product. In addition, they must have carefully read, understood and comply with these instructions and, in particular, the safety instructions.

	Mechanic* (2)	Electrician* (2)	Transport staff* (2)	Trainees / Interns* (3)	Third* (3)
Transport			X		
Assembly	X	X			
Installation	X	X			
Storage	X	X	X		
Disposal	X	X	X		

\*)For reasons of better readability, the simultaneous use of the language forms male, female and diverse (m/f/d) is waived. All personal terms apply equally to all genders.

- 1) unskilled or inexperienced, if applicable
- 2) qualified or instructed person
- 3) no training, no experience, lack of risk awareness





## 2.4 Compliance with the assembly instructions

Carefully read all of these assembly instructions before assembling/operating the unit. These include everything you need to know for assembly/commissioning and to avoid damage to persons/objects/the environment.

Carefully observe all the safety information, requirements and information in these assembly instructions.

## 2.5 Residual risks and protective measures

Below is an overview of all the overall residual risks and protective measures which apply to these assembly instructions. The product corresponds to the state of the art at the time of delivery and can be regarded as safe to operate

	<p style="text-align: center;"><b>⚠ DANGER</b></p> <p>Electrical voltage</p> <ul style="list-style-type: none"> <li>- Will cause serious or fatal injuries</li> <li>▪ Work may only be performed by competent personnel</li> <li>▪ Observe the general rules for electrotechnical safety</li> <li>▪ Immediately replace damaged parts, cables or plugs</li> </ul>
	<p style="text-align: center;"><b>⚠ WARNING</b></p> <p>Lubricants are combustible</p> <p>Can cause serious or fatal injuries</p> <p>Can cause damage to property or other subsequent damage</p> <ul style="list-style-type: none"> <li>▪ In case of fire, only use suitable extinguishing agents such as foam, dry chemical powder, carbon dioxide</li> <li>▪ Observe the safety advice from the lubricant manufacturer</li> <li>▪ Observe personal safety advice and instructions on how to act in the event of fire</li> </ul>
	<p style="text-align: center;"><b>⚠ CAUTION</b></p> <p>Batteries</p> <ul style="list-style-type: none"> <li>- Can result in minor to moderate injuries</li> <li>▪ Avoid eye, skin and clothing contact with battery substances</li> <li>▪ Do not swallow any leaking battery substances</li> <li>▪ Do not exceed the specified temperature</li> <li>▪ Do not open batteries</li> </ul>
	<p style="text-align: center;"><b>⚠ CAUTION</b></p> <p>Lubricants</p> <p>Can cause minor or less severe injuries as well as damage to property</p> <ul style="list-style-type: none"> <li>▪ Intensive contact with lubricants over longer periods can cause skin irritation</li> </ul>
	<p style="text-align: center;"><b>NOTICE</b></p> <p>Warning against pollution of the environment</p> <ul style="list-style-type: none"> <li>▪ Lubricants (oils and greases) are hazardous substances that can pollute the contaminate soil and water</li> <li>▪ Prevent the lubricant from entering drains, drains, sewers and watercourses</li> <li>▪ Use and dispose of lubricants properly</li> </ul>



### 3. Technical data

#### 3.1 Short description

The drive unit is available in the following variants: with battery power supply (MD400-B), connection to an external power supply with 24VDC (MD400-V) or external power supply with 24VDC (MD400-B). to an external power supply with 24VDC (MD400-V) or external power supply with 24VDC via a PLC (MD400-D). In combination with the lubricant cartridge, this is a single-/multi-point lubrication system with double piston pump for lubricants. The two pistons are positively controlled in opposite directions. The outlet is secured by an integrated non-return valve. Approx. 0.15 ml of lubricant is delivered with each dosing process. is dispensed; multiple dispensings in succession are possible. Depending on the version, the different operating states are Depending on the version, the various operating states are shown on the front display. cartridge) can also be read off. The operating mode and the quantity of lubricant pumped per unit of time can be set via the quantity of lubricant delivered per unit of time for the version with display, in order to supply the lubricating point with the optimum amount of lubricant. The drive units with power supply 24VDC can be integrated into an external control system. (e.g. PLC) These versions enable remote monitoring by means of output signals, in order to be able to query the status and possible error messages (e.g. empty cartridge)

Lubricator			
Type	MD 400 - B	MD400- V	MD400- D
Version	Batteriebetrieb	24V DC	24V DC
Dimension drive unit	107 x 56,5 x 108 (B x H x T) mm		
Dimension with upper part	107 x 198,5 x 108 (B x H x T) mm		
Weight drive unit with upper part	approx. 1100g		
Mounting position	vertical		
Mounting option	Through hole for M6		
Maximum tightening torque	6 Nm		
Material of housing	Zinc die-cast / PA 6.6 GF30 / POM		
Operating temperature	-15°C bis +60°C **		
Hydraulics			
Lubricant cartridge*	400ml		
Pumpable lubricants	Grease up to NLGI class 2 and oil		
Number of outlets	1 / 2	1 / 2	1 / 2 / 3 / 4
Hydraulic connection	via PA hose		
Number of lubrication points	without accessories up to 4 ** up to 16 in conjunction with splitter* ** up to 20 in connection with progressive splitter* **		
Maximum pressure	70 bar (-10% / +15%)		
Maximum operating pressure	50 bar		
Displacement per stroke	0,16 ml (-5%)		
Electrics			
Operating voltage	6V	24V	24V
Protection class	IP 54		
Fuse protection	-	0,75A (träge)	
Power consumption	-	I <sub>max</sub> <0,3A I <sub>Ruhe</sub> <0,025A	
Connection plug	-	M12x1 4-polig	

\* Additionally available accessories

\*\* The specified value depends on the specific application and may vary considerably in individual cases depending on the lubricant used and other conditions.

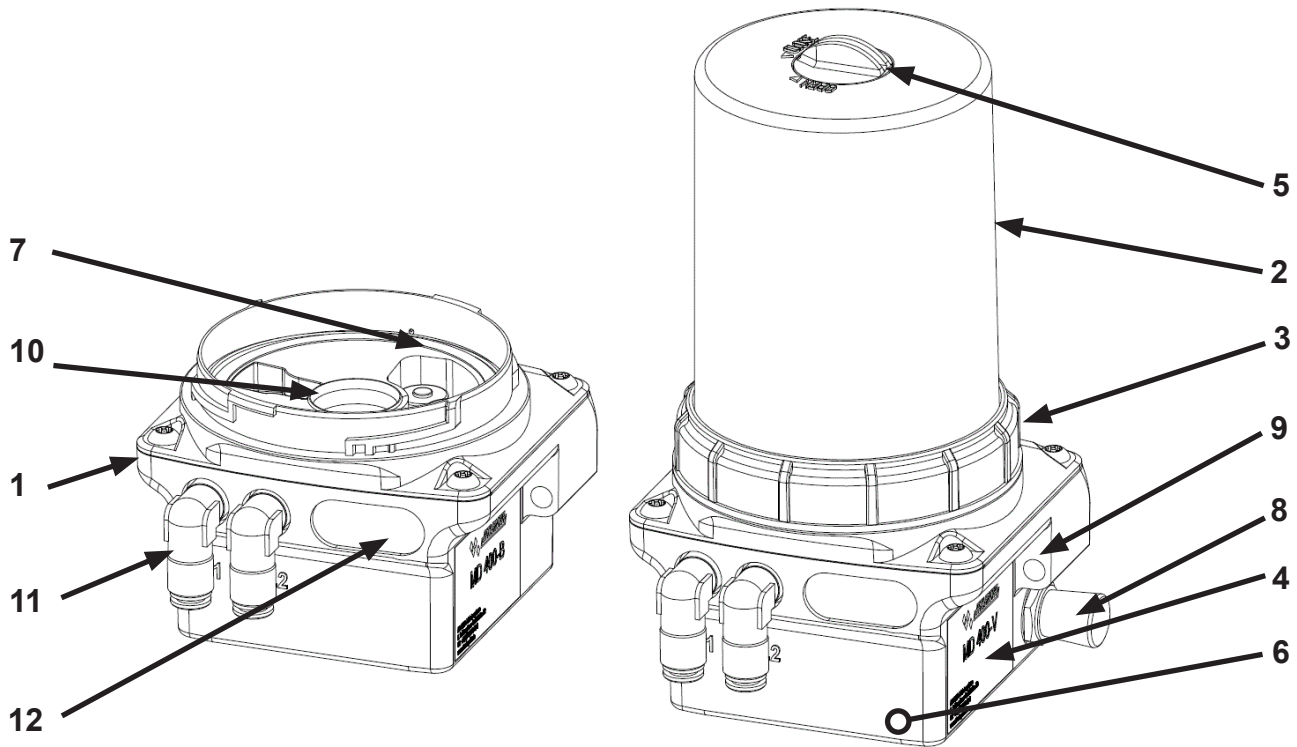

Nr.	Benennung
1	Drive unit
2	Protective cover
3	Swivel nut
4	Type plate with information and serial no.
5	Magnetic pen *
6	Action area for magnetic pen *
7	Battery compartment *
8	Electronic interface *
9	Fastening hole
10	Lubricant inlet with thread for cartridge
11	Lubricant outlet Ø6mm (number depending on version)
12	LCD-Display *

\* Depending on version

### 3.2 Labelling

The drive unit is marked with a type plate (see above). The type, the item number and the serial number as well as other information.

## 4. Delivery, internal transport, unpacking

	<b>⚠ CAUTION</b>
	<p>Damage to the drive unit</p> <ul style="list-style-type: none"> <li>• May result in property damage or consequential damage</li> <li>▪ Inspect the drive unit when it is delivered, If the drive unit is damaged, please complain immediately</li> <li>▪ Do not allow any further use of the drive unit</li> <li>▪ Do not throw the drive unit</li> <li>▪ Do not drop the drive unit</li> </ul>

The drive unit is packed in an outer packaging ( carton box) for transport.

To facilitate initial commissioning, it is pre-filled with a neutral, food-grade (H1) lubricant (approx. 3 cm<sup>3</sup>), which can be mixed with our lubricants.

The manufacturer's designation is Total Ceran FG

We recommend removing the outer packaging of the drive unit only at the place of use.

### 4.1 Storage

If the drive unit is not installed immediately after delivery, the following measures must be taken:

For storage of the drive unit, leave it in its packaging and observe the following instructions:

- Store add-on parts such as mounting axles separately. (Protect steel parts from corrosion)
- Storage temperature +5°C to +30°C
- Relative humidity 30-60%
- Protect the drive unit and attachment parts from environmental influences (ozone, UV light, electric welding, dust, dirt, moisture, vibrations, etc.).
- For storage logistics, we recommend the "first in - first out" principle.
- The max. storage time under these conditions is 2 years.

### 4.2 Unpacking

- Unpack the delivered items from the transport packaging/outer packaging.
- Carefully remove the transport packaging/outer packaging.
- Use suitable tools to open the packaging.
- Check scope of delivery for completeness and damage.

If the scope of delivery is incomplete or damaged:

Document damage / missing parts and report to the transport company.

Comply with the current national regulations for disposing the packaging!

If required, dispose of the individual components separately depending on their nature and any existing specific national regulations.

## 5. Assembly and installation

### 5.1 Assembly preparation

	<b>⚠ WARNING</b>
	<p>Damage to the drive unit</p> <ul style="list-style-type: none"> <li>- May result in property damage or consequential damage</li> <li>▪ Do not use compressed air</li> <li>▪ Make sure that there is no coarse dirt in the motor area. there is any coarse dirt in the motor area</li> <li>▪ Prevent dirt, water and foreign bodies from entering the lubrication system</li> </ul>

The drive unit must be checked for external damage and contamination.

Damaged parts must neither be installed nor operated.

The information on the type plate must be checked against the order.

Check whether the drive unit is suitable for the present operating conditions.

Please refer to the section on areas of application.

When installing in the food, chemical and pharmaceutical industries, the relevant national and international regulations must be observed.

national and international regulations must be observed.

Check this also for the attachments used.

### 5.2 Mounting the drive unit

The drive unit should be mounted in an easily accessible and visible location.

Before mounting, the lubrication point must be lubricated through with a hand grease gun.

Please note that the same lubricant must be used for lubrication as in the lubricant cartridge to be used later.

It is recommended to remove the protective caps only at the place of use in order to prevent penetration of foreign substances, among other things.

Remove the protective caps as follows:

Remove the protective cap for the lubricant inlet (Pos.1) in axial direction

and, if necessary, the protective cap for the electronic interface (Pos.2).

The high pressure hose Ø6mm can be inserted into the lubricant outlet (Pos.3).

The lubricant cartridge is an accessory: the assembly of the lubricant cartridge with the drive unit is explained in additional instructions (BKI 215).

Closing / blocking individual lubricant outlets (Pos.3) is not permitted - this will lead to overload or damage to the drive unit.

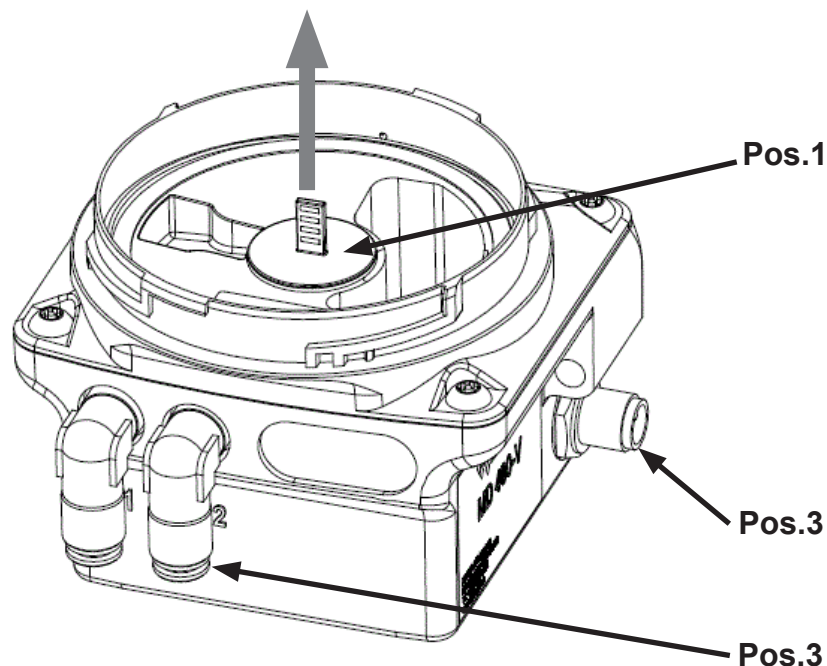

### 5.3 Power supply drive unit

The drive unit is available in the variants B (battery operation), V (external power supply) and D (external power supply via PLC).

The power supply and control software differ depending on the variant selected.

### 5.4 Connecting the electrical interface

Connect the plug connection of the drive unit with a suitable connection cable to the external voltage source or external machine control (programmable logic controller) via the M12x1 interface on the side of the drive unit.

Depending on the application, connection cables with straight or angled sockets can be used.

For the condition of the connection cable, please refer to the section Electrical connection.

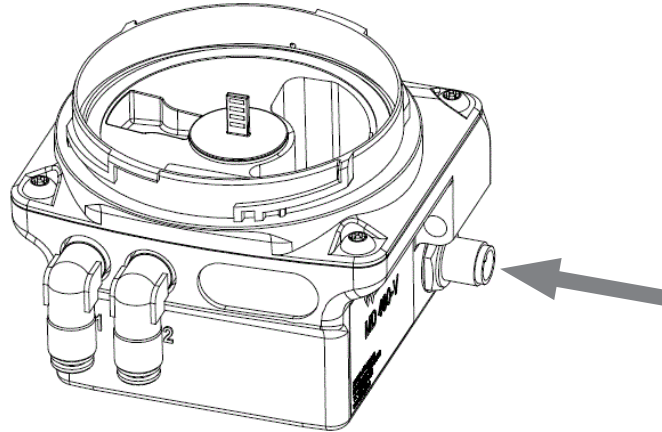

### 5.5 Connecting the battery

Pull the battery cable out of the battery compartment.

Connect the battery to the battery cable via the reverse polarity protected plug.

Stow the battery and the battery cable in the battery compartment.

Make sure that the battery cable or the plug does not protrude from the battery compartment.

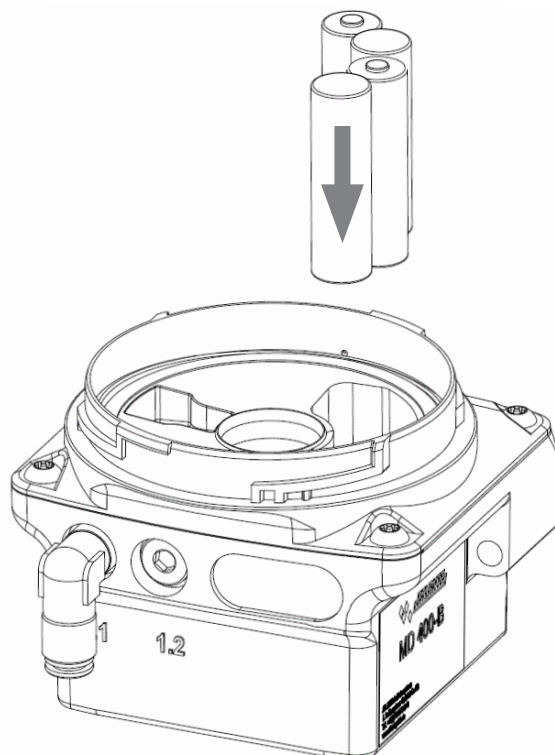

### 5.6 Mechanical fastening

The drive unit can be fixed through the two through holes with one M6x40 each at the rear. Note that the threads may be tightened with a maximum of 5Nm.

The drive unit must be installed in a vertical position.

### 5.7 Electrical connection

The battery variant is supplied with voltage by the battery pack.

For the variant for external power supply or external control (PLC), the pin assignment is as shown below. Attention! The output signal at PIN4 must not exceed a maximum output current of <20mA, and no inductive load (e.g. relay) may be connected.

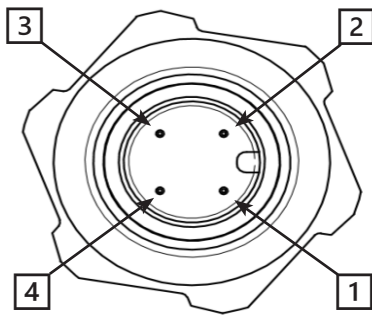

Pin Occupancy- Time control / external control		
Pin	Occupancy	colour
1	+24 V DC	brown
2	Input signal from control (PLC)	white
3	Ground (GND)	blue
4	Output signal to consumer or to control (SPS)	black
Type M12x1 socket, 4-pin, A-coded		

## 6. Start-up

### 6.1 Checking the installation

Before commissioning, ensure that mechanical attachment and electrical connection have been performed properly and that the hydraulic connection to consumers has been laid tidily and properly. If connecting hoses have been used, ensure that they are laid without strain or kinks.

We recommend that all hoses and distributors are filled before commissioning using the additional filling adapters available or via the filling function of the unit.

### 6.2 Mounting accessories

After installing the drive unit, the necessary or desired accessories should be installed.

Please refer to the relevant instructions for the procedure, e.g. installation of the lubricant cartridge.

### 6.3 General

Depending on the configuration and setting, the drive unit can also reliably supply a number of lubrication points to be defined. The use of splitter or progressive distributors is also possible. Refer to the individual sections for further details of the programming and control.

If you have any questions about your application and the correct settings for it, please contact ATLANTA Antriebs-systeme GmbH directly.

The respective statuses of the drive unit can be seen on the display during battery operation and with an external power supply (versions B and V).

For version D, the statuses are only output via the electrical connection.

Depending on the version, the drive units have the following setting options.

#### Hour mode -h-

-This allows the pause time (h) and the number of dispensing cycles (c) between two cycles to be set. Pause times (h) between 1 and 240 hour(s) and cycles (c) between 1 and 30 can be set.

#### Emptying time

-This allows the emptying time in months to be set; emptying times from 1 to 36 month(s) can be set.

#### Pulse mode is not possible during battery operation (version B).

-In versions V and D, this enables control via an external machine controller for synchronisation with the machine running time.

**Please note that all the following chapters presuppose a lubricant cartridge installed on the drive unit and a power supply.**

## 6.4 Factory settings

Check whether the set factory settings of the drive unit version B and V can be used for your application. If not, adjust the settings to your requirements.

The drive unit is delivered with the following settings.

Mode: OFF

Cartridge size: 400ml

Operating mode = hour mode -h-

Pause time h=3 (pause between lubrication cycle is 3 hours)





Number of cycles c=1 (the lubrication cycle is executed once (1))

The procedure for changing the settings is described in the following chapters.

## 6.5 Menu and messages on the display

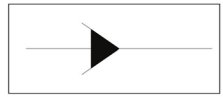
Information can be read visually via the display of the drive unit. Settings can be changed (in connection with the magnetic pin attached to the upper part) or trigger individual actions. In principle, settings can be changed and actions triggered both in the switched-off state (OFF) and in the switched-on state (ON).

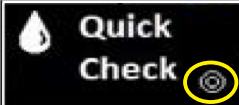
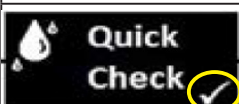
(ON) state, settings can be changed and actions triggered. Description of the symbolic representations used below:

Symbol	Naming	Note
	Display indicator	The OLED shows displays and information both in operation and for programming
	Drainage arrow	The black sequence arrow indicates the unchangeable basic structure of the menu
	Action arrow	The action arrow shows the consequence of touching the action area with the magnetic pen
	Sub-menu	In the respective sub-menus, information can be read, donation processes can be initiated and settings can be changed
	Magnetic pen detected	The double circle in the lower right corner is displayed when the magnetic pen the action area with the magnetic pen (magnetic pen detected)
	Adoption of modified value	The confirmation tick in the lower right corner is displayed when an entry has been confirmed. In addition, the display flashes double
	Screensaver	In the ON and OFF state, the screen saver is activated after a short time. ON and OFF are shown in the display as a scrolling text

### 6.6 Program structure

The following diagram illustrates the basic predetermined structure of the drive unit menu guidance as well as the possibilities of branching to the sub-menus.

The drive unit can be switched on and off (ON/OFF) at several points.

The Info menu can only be called up when the drive unit is switched off. The menu provides only information about the current settings.

The settings menu can only be called up when the drive unit is switched off. This menu allows changes to be made to the operating mode and the size of the cartridge used to be set.





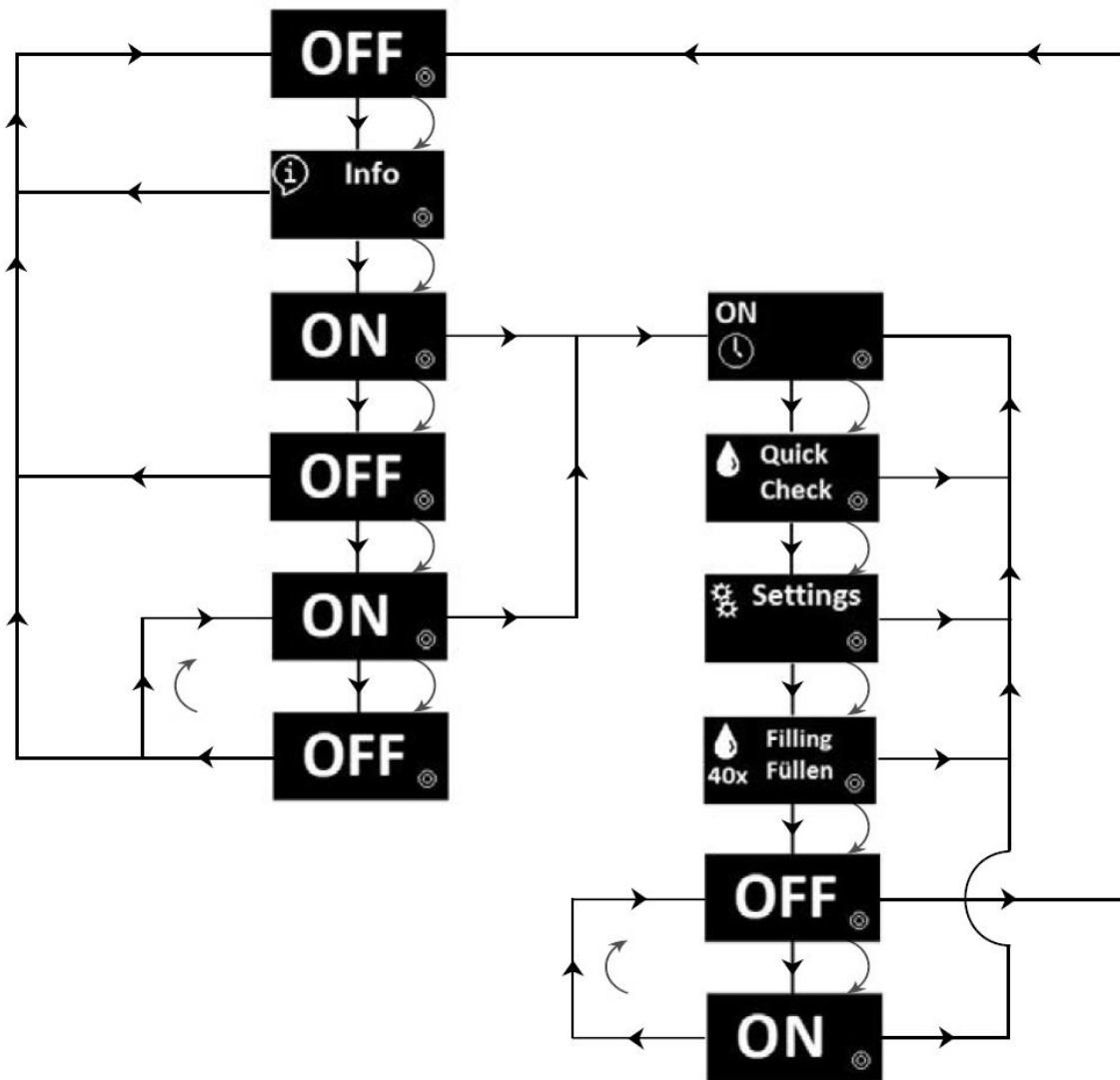







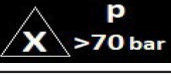





The Quick Check menu can only be called up when the drive unit is switched on. The menu allows individual dispensing cycles of the lubricator to be performed manually.

The Filling menu can only be called up when the drive unit is switched on. In this menu, a fixed number of dispensing cycles can be performed manually.

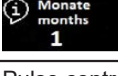
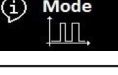



## 6.7 Legend for display for variant B and V

Display	Meaning
No display	Power supply not connected
OFF	Drive unit switched off
ON	Ready for operation; drive unit delivers lubricant according to set operating mode and set values
	Drive unit in pulse mode PUL ready for operation and waiting for control signal from the external control (PLC). !!! Attention only for version with power supply !!!
Störungen (Fehler)	
	Error E1 (Empty cartridge / cartridge error / cartridge not installed)
	Error E2 (overload)
	Error E3 (undervoltage)
	Error E4 (Serious error)
Submenus	
	Info menu (information menu)
	N41 Firmware version of the drive unit
	Mode Selected operating mode
	Value Currently set value of the pause time h or value of the emptying time Et
	Value Current set value of the number of cycles c
	Currently set value of the cartridge size
	Number of completed lubrication strokes C
	Settings menu (basic settings)
	Operating mode Hour mode you can set the lubrication cycle duration in hours between two lubrication cycles and additionally the number of lubrication strokes per pump cycle
	Adjustable setting of the pause time h1...240
	Adjustable setting of the number of cycles c1...10
	Operating mode Emptying time you can set the emptying time in months (running time) and additionally the number of lubrication strokes per pump cycle for a complete cartridge
	Adjustable setting of the emptying time Et 01...24
	Pulse control operating mode, you can trigger lubrication strokes and actions with the help of an external control or PLC and certain signals. !!! Attention only for version with power supply!
	Adjustable cartridge size setting 125ml / 250ml
	Quick Check-Menu
	During the manually triggered Quick Check command, a lubrication cycle is executed and the display shows the approximate back pressure in bar per outlet
	Filling / Füllen-Menu
	During the manually triggered active filling command, the display shows the approximate back pressure in bar
	If the process is interrupted during the filling command, Stop first appears in the display

### 6.8 Switching ON

When you want to put the drive unit into operation, switch it on with a magnetic pen (1). This is mechanically secured in the protective hood (2). Remove the magnetic pen (1) from the protective hood (2) and place it on the action panel of the drive unit (3). As soon as the magnetic pen is detected on the action panel (3), a double circle is shown in the bottom right corner of the display. Leave the magnetic pen on the action panel until -ON- appears on the display. Remove the magnetic pen (1) from the action panel (3) while -ON- is still shown on the display. The double circle disappears and a check mark is displayed. If no fault is detected during the self-check of the drive unit, the display shows -ON-. The drive unit is now ready for operation and will dispense lubricant according to the set values.

After completing a setting, always return the magnetic pen (1) to the position provided for it on the hood of the drive unit or store the magnetic pen in a convenient place. Please note, however, that in the event of malfunctions or if changes have to be made, no changes or actions can be carried out without the magnetic pen.

For details of the control of drive unit version D or V with active pulse mode, please refer to chapter "Controller input/output signals" and its sub-chapters.

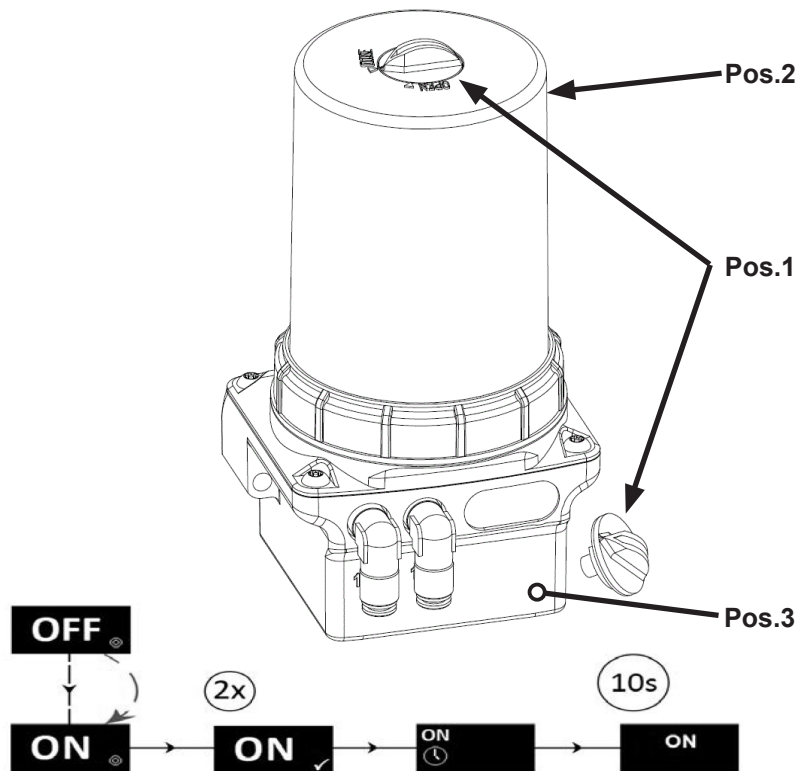

### 6.9 Switching OFF

When you want to switch off a running drive unit, place the magnetic pen on the action panel and leave it there until -OFF- appears on the display.

The drive unit can be switched off in any state (normal operating state or error) in the manner described here. Please refer to the diagram below for the program structure:

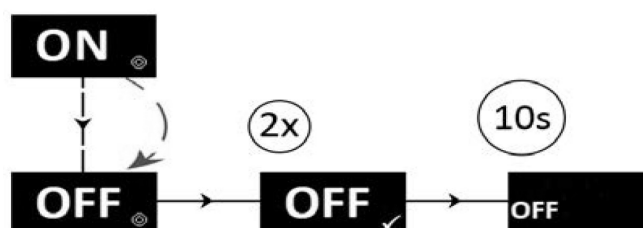

### 6.10 Checking and changing settings

Before switching on, we recommend that you check the set values.

Use the magnetic pen to make and change settings; hold it on the action panel until the desired menu item is shown on the display. Remove the magnetic pen from the action panel while the desired menu item is still shown on the display to call up the menu item.

To change the values, place the magnetic pen briefly on the action panel and remove it again when your desired setting is displayed.

If you don't want to change values, the magnetic pen must not touch the action panel.

After successfully changing the setting, the drive unit starts a lubrication cycle with the set values.

During each lubrication cycle, the approximate back-pressure is shown on the display.

### 6.11 Info menu

The Info menu (information menus) is used to inform the user about the firmware used and the settings that have been made and are currently in use.

The Info menu can only be called up when the drive unit is switched off.

The Info menus differ, depending on the selected mode.

Please refer to the diagram below for the program structure:

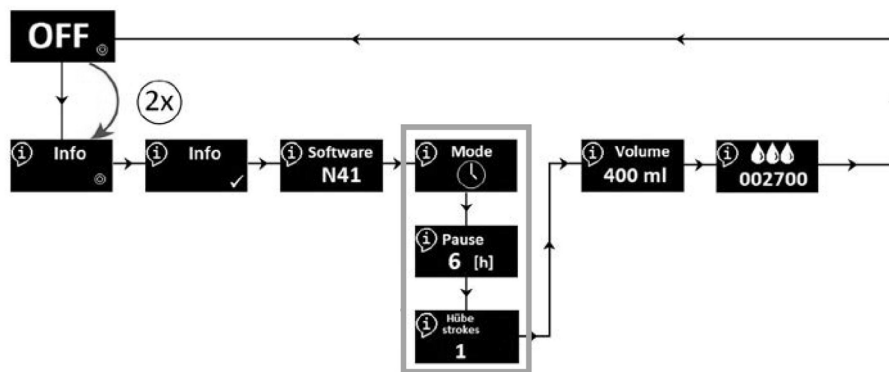

Info menu (information menu)	
N41	Firmware version of the drive unit
Mode	Selected operating mode
Value	Currently set value of the pause time h or value of the emptying time Et
Value	Current set value of the number of cycles c
Volume 400 ml	Currently set value of the cartridge size
002700	Number of completed lubrication strokes C
Settings menu (basic settings)	
Mode	Operating mode Hour mode you can set the lubrication cycle duration in hours between two lubrication cycles and additionally the number of lubrication strokes per pump cycle
Pause 6 [h]	Adjustable setting of the pause time h1...240
Hülbe strokes 1	Adjustable setting of the number of cycles c1...10
Mode	Operating mode Emptying time you can set the emptying time in months (running time) and additionally the number of lubrication strokes per pump cycle for a complete cartridge
Monate months 1	Adjustable setting of the emptying time Et 01...24
Mode	Pulse control operating mode, you can trigger lubrication strokes and actions with the help of an external control or PLC and certain signals. !!! Attention only for version with power supply!
Volume 400 ml	Adjustable cartridge size setting 125ml / 250ml

### 6.12 Settings menu

The Settings menu allows you to change the operating mode and the cartridge size.

The Settings menu can only be called up when the drive unit is switched on (ON). It allows you to change the dispensing setting.

The following modes are available:

Battery operation:

-Hour mode, emptying time mode, cartridge size

External power supply:

-Hour mode, emptying time mode, pulse mode, cartridge size

The operating mode can only be changed when the drive unit is switched on (ON).

Please refer to the diagram below for the program structure:

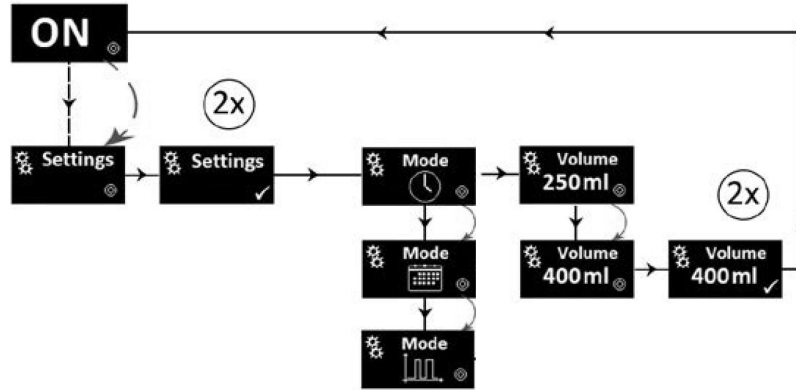

Settings menu (basic settings)	
	Operating mode Hour mode you can set the lubrication cycle duration in hours between two lubrication cycles and additionally the number of lubrication strokes per pump cycle
	Adjustable setting of the pause time h1...240
	Adjustable setting of the number of cycles c1...10
	Operating mode Emptying time you can set the emptying time in months (running time) and additionally the number of lubrication strokes per pump cycle for a complete cartridge
	Adjustable setting of the emptying time Et 01...24
	Pulse control operating mode, you can trigger lubrication strokes and actions with the help of an external control or PLC and certain signals. !!! Attention only for version with power supply!
	Adjustable cartridge size setting 125ml / 250ml

### 6.12.1 Setting menu -Hour mode-

Here you can change the pause time -h- between the dispensing cycles and the number of lubrication cycles -c- (number of strokes) during the dispensing cycle.

Please refer to the diagram below for the program structure:

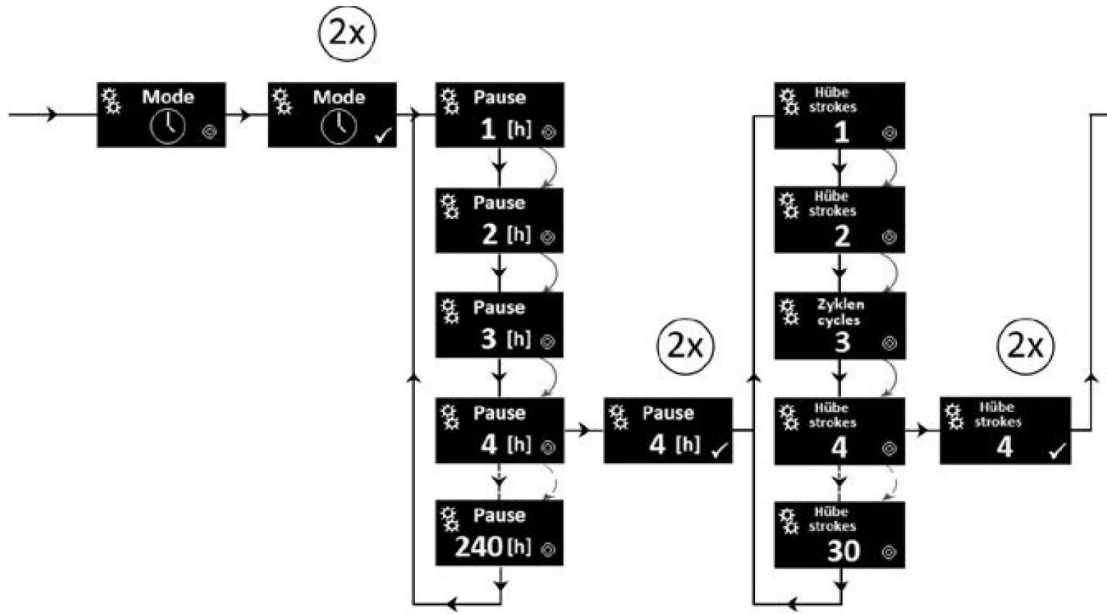

### 6.12.2 Setting menu -Emptying time mode-

Here you can set the emptying time -Et- in months and the number of lubrication cycles -c- (number of strokes) to be carried out. The drive unit automatically calculates the pauses between the lubrication cycles.

Please refer to the diagram below for the program structure:

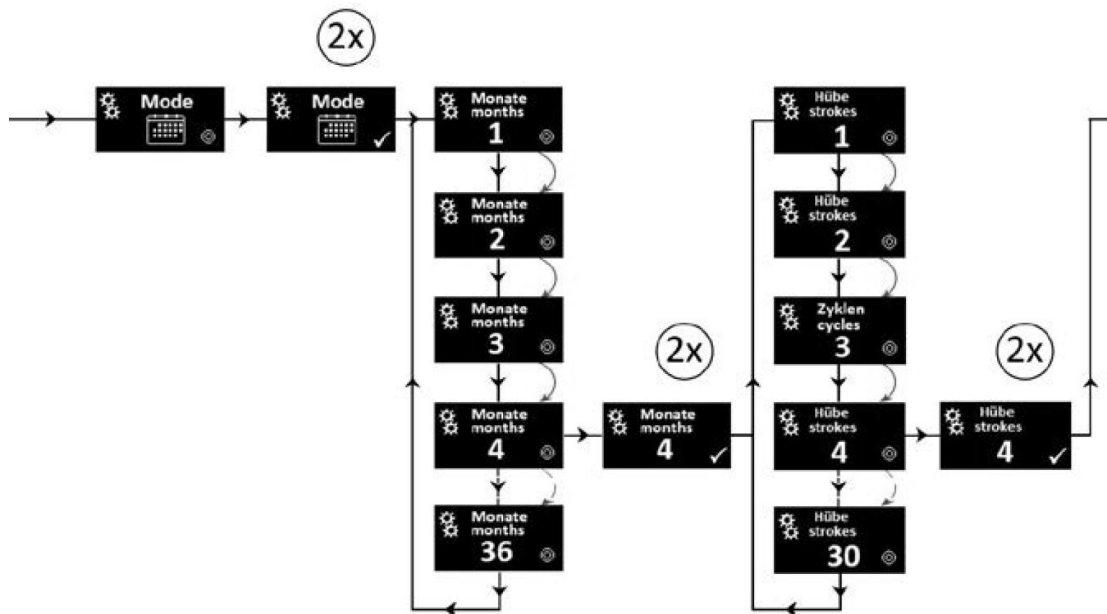

### 6.12.3 Setting menu -Pulse mode-

Only for drive units with external power supply (versions V and D):

No settings can be made here; the dispensing cycles are controlled via the connection to a control PLC.

Here, ON and a pictogram are shown on the display for purely informative purposes with version V.

For the pin assignment and control of the drive unit, please refer to chapter “Controller input/output signals”.

### 6.13 Quick Check menu

The Quick Check menu is used to manually activate a lubrication cycle. Depending on the selected operating mode, a lubrication cycle or the value for the lubrication cycles -c- set in hour/emptying time mode is used here. The approximate back-pressure at the active outlet port is shown on the display.

If there are multiple outlet ports, they are designated 1.1 and 1.2.

The Quick Check can only be started in hour/emptying time mode.

Please refer to the diagram below for the program structure:

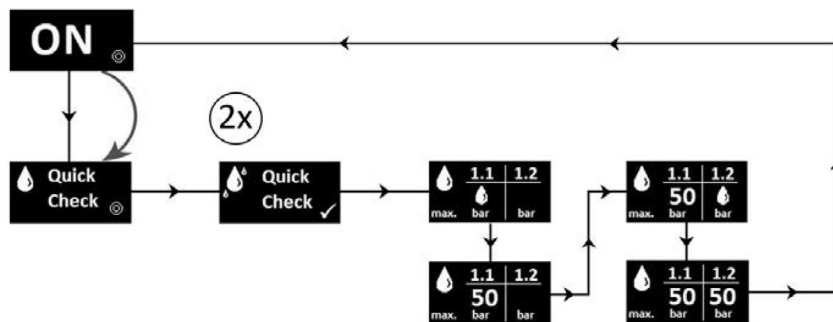

### 6.14 Filling menu

The Filling menu is used for the initial start-up of the lubrication system and for filling the accessories connected to the drive unit.

When activated, 40 lubrication cycles are performed with the lubricant in the lubricant cartridge.

To cancel the process, place the magnetic pen on the action panel and wait until the message STOP appears on the display; when the magnetic pen is removed, the filling process is cancelled.

The approximate back-pressure is shown on the display during the dispensing cycle.

Please refer to the diagram below for the program structure:

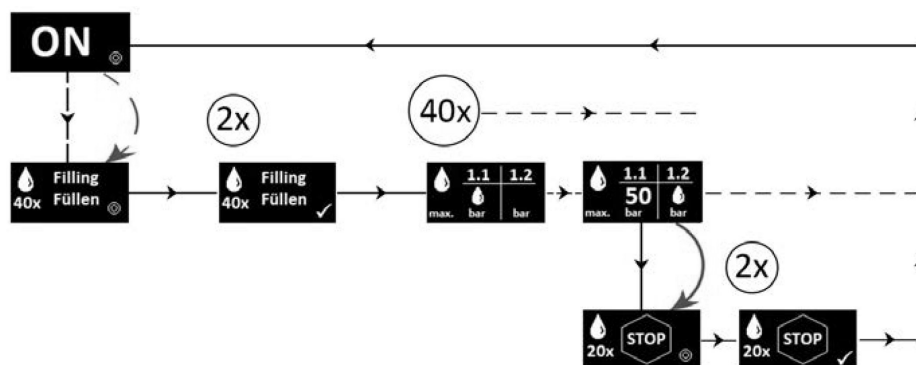

## 7. Control of input and output signals

Only for drive unit variant V and D with external power supply

	<b>! WARNING</b>
	Damage to the drive unit - May cause property damage or consequential damage <ul style="list-style-type: none"> <li>▪ The output signal at PIN4 must not exceed <math>I_{max}</math> 20mA</li> <li>▪ No inductive loads (e.g. relays) may be connected</li> </ul>

The drive unit can be switched off completely by disconnecting the external power supply.

The settings made in hour mode -h- or emptying mode -Et- are not lost in the process.

The time elapsed before switching off until the scheduled lubrication cycle is stored internally.

After switching on the external power supply, the lubrication system checks itself automatically and continues to operate according to the set values.

After a longer standstill of the drive unit, manual execution of the run mode is recommended.

### 7.1 Output signals in hour -h- or emptying mode -Et-.

In this mode, the drive unit provides output signals at PIN 4. If required, the operating states can be processed externally. Basically, the output signals can only be sampled.

For the meaning, see the table below:

LCD	Bezeichnung	Ausgangssignal (PIN4)
OFF	Switched off	Low, permanent
ON	Ready for operation	High, permanent
E1	Empty cartridge	0.5Hz square wave signal, permanent
E2	Overload	Low, permanent
E3	Undervoltage	Low, permanent

A permanently present high level (+24V) at PIN 4 means that the lubricator is ready for operation and there is no error.

A permanently and permanently present low level (0V) at PIN 4 means that the lubricator is switched off or, if switched on, there is an error. The error must be read on the LCD.

### 7.2 Control in pulse mode (PUL)

In order to operate the drive unit on the machine control (PLC), the drive unit variant V must first be switched to pulse operation (PUL).

In this operating mode, the drive unit only works if the input signals (high level) have been transmitted in a defined sequence from the machine control (PLC) via PIN 2. The respective status can be transmitted to the machine control (PLC) via high / low level, which are tapped at PIN 4.

For integration into the external machine control (PLC), one input and one output must be provided on the control side.

The control signals are to be generated by the machine control (SPS) via the M12x1 interface as high level (+24V DC) in a certain time with a tolerance of +/-0.1 seconds each.

The drive unit can be switched off completely by switching off the supply voltage.

After the supply voltage is reconnected, the drive unit checks itself automatically and only operates after receiving an input signal.

The drive unit can only process the control signals listed in the following table up to a maximum length of 14 seconds; if this is longer, the drive unit will not react.

If a signal is present at PIN2 for longer than 15 seconds, there is no reaction; in the case of variant V, --- is displayed in the LCD.

**7.3 Control signals**

Control signals are fed in at PIN 2, the operating states are output via PIN 4 as high / low levels and must be processed accordingly in the PLC.

In the ready-to-operate state, 24V (High) are constantly present at PIN 4.

Function	Designation	Signal length (PIN2) in seconds	valid for
1 stroke on Pump 1	Lubrication cycle on Pump 1	2 s high	V1, V2; D1, D2, D3, D4, D1-1
1 stroke on Pump 2	Lubrication cycle on Pump 2	5 s high	D3, D4, D1-1
1 stroke on Pump 1/2	Lubrication cycle on Pump 1 and pump 2	8 s high	D3, D4, D1-1
FIL function	Filling function	12 s high	V1, V2; D1, D2, D3, D4, D1-1
Error acknowledgement	Clear error	14 s high	V1, V2; D1, D2, D3, D4, D1-1



### 7.3.1 2 seconds control signal

The 2 seconds control signal at PIN 2 triggers a single dispensing cycle (motor run ML). After a pause of 22 seconds, this control signal can be repeated or another control signal can be sent.

Immediately after triggering the dispensing process, the signal at PIN 4 drops to a low level for the duration of the dispensing process. This can take between 7 and 17 seconds, depending on the system configuration.

Depending on the version, the active outlet port is shown on the display during the dispensing process; at the end of the dispensing process, the approximate back-pressure is shown in bar.

A new control signal can be sent to the controller (PLC) at the earliest 3 seconds after the end of the error-free dispensing process. The drive unit does not process any control signals in the meantime.

Please refer to the diagram below for a visual representation:

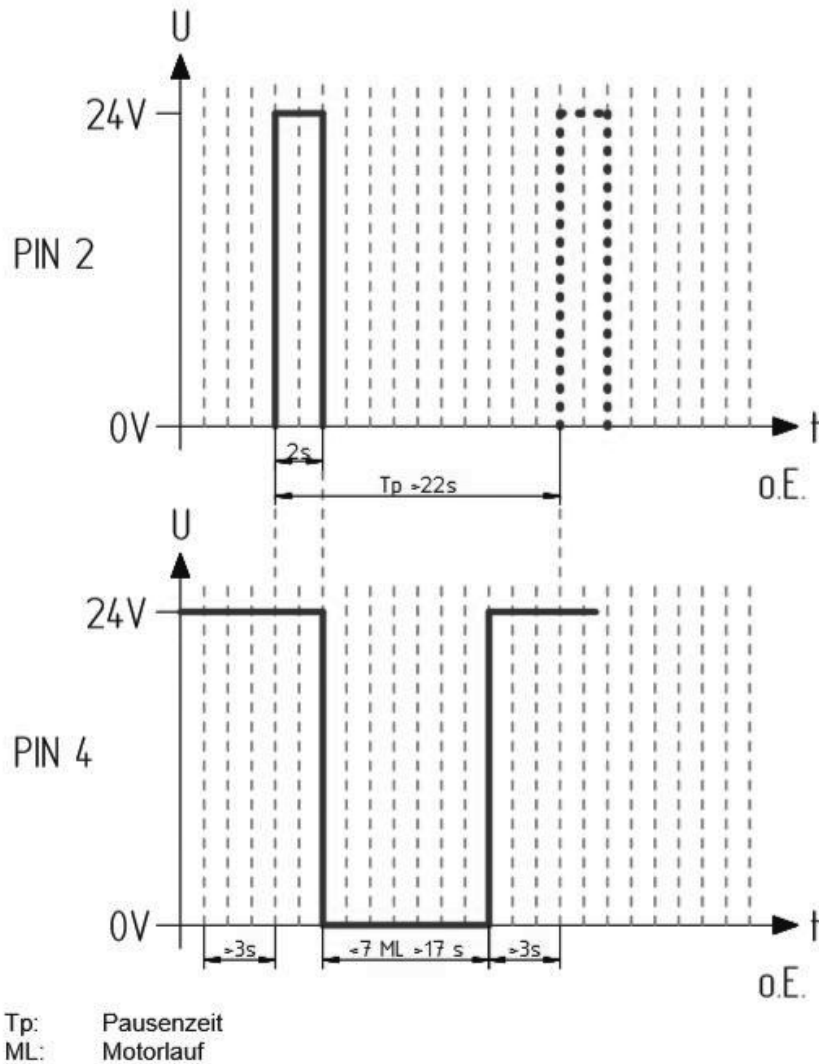

### 7.3.2 5 seconds control signal

Possible only with version D

The 5 seconds control signal at PIN 2 triggers a single dispensing cycle (motor run ML) at pump body 2. After a pause of 25 seconds, this control signal can be repeated or another control signal can be sent.

Immediately after triggering the dispensing process, the signal at PIN 4 drops to a low level for the duration of the dispensing process. This can take between 7 and 17 seconds, depending on the system configuration.

A new control signal can be sent to the controller (PLC) at the earliest 3 seconds after the end of the error-free dispensing process. The drive unit does not process any control signals in the meantime.

Please refer to the diagram below for a visual representation:

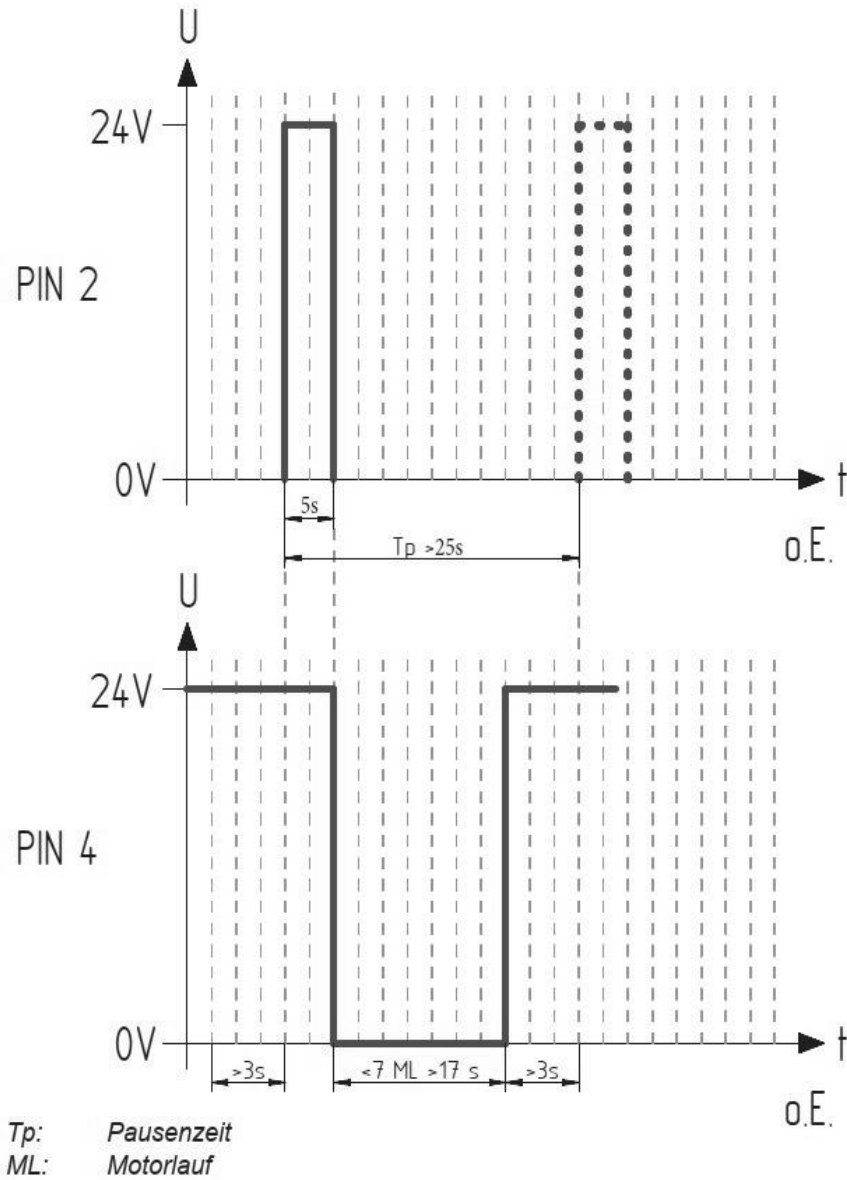

### 7.3.3 8 seconds control signal

Possible only with version D

The 8 seconds control signal at PIN 2 triggers a single dispensing cycle (motor run ML) at both pump bodies in succession. After a pause of 45 seconds, this control signal can be repeated or another control signal can be sent.

Immediately after triggering the dispensing process, the signal at PIN 4 drops to a low level for the duration of the dispensing process. This can take between  $2 \times 7$  and  $2 \times 17$  seconds, depending on the system configuration.

A new control signal can be sent to the controller (PLC) at the earliest 3 seconds after the end of the error-free dispensing process. The drive unit does not process any control signals in the meantime.

Please refer to the diagram below for a visual representation:

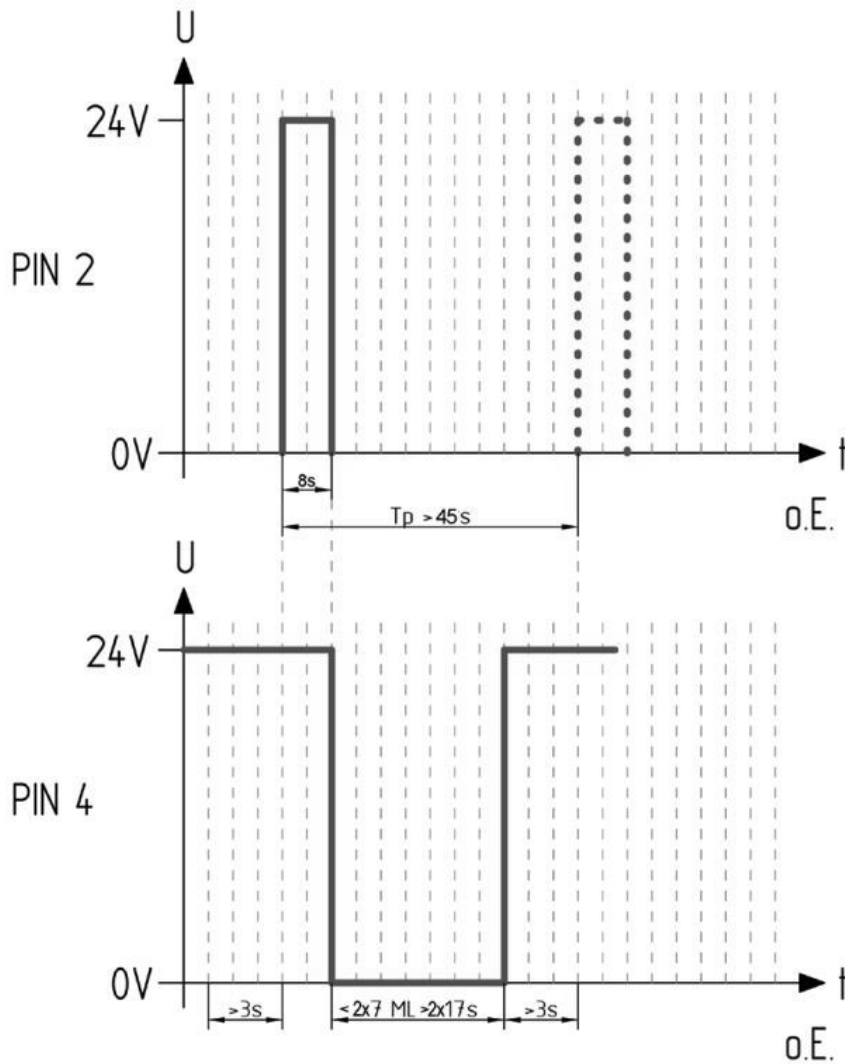

### 7.3.4 12 seconds control signal

The 12 seconds control signal at PIN 2 triggers the FIL function. A total of 40 dispensing processes (motor runs ML) are performed in succession. After a pause of at least 706 seconds, this control signal can be repeated or another control signal can be sent. Immediately after triggering the FIL function, the signal at PIN 4 drops to a low level for the duration of the dispensing process. This can take between 7 and 17 seconds, depending on the system configuration.

At the end of the dispensing process, the signal at PIN 4 rises to high level for a short time until the next dispensing process.

Depending on the version, the active output port is shown in the display during the dispensing process. After the end of the dispensing process, the approximate back-pressure is displayed in bar.

A new control signal can be sent by the controller (PLC) at the earliest 3 seconds after the end of the error-free dispensing process. The drive unit does not process any control signals in the meantime.

For drive units with two pump bodies, 40 dispensing processes per pump body are triggered after the 12 seconds control signal is triggered. This doubles the pause time ( $T_p$ ).

Please refer to the diagram below for a visual representation:

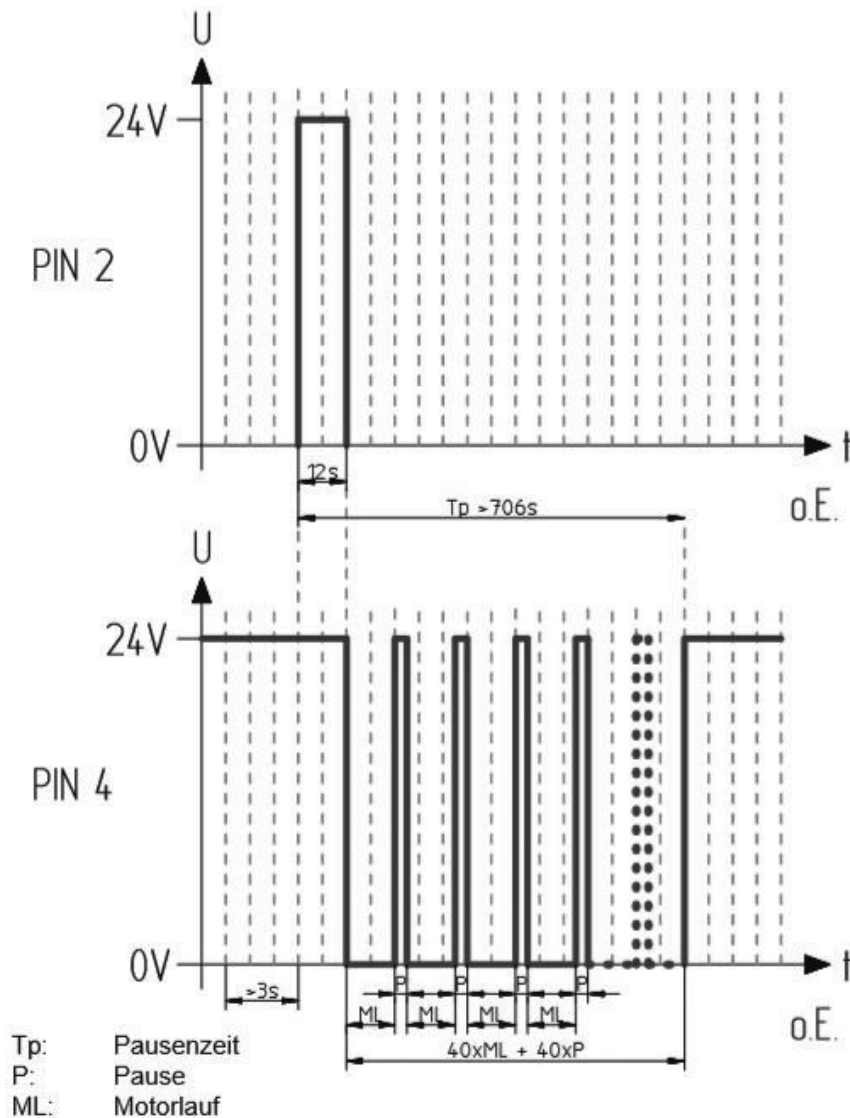

### 7.3.5 14 seconds control signal

The 14 seconds control signal at PIN 2 triggers the acknowledgement of error messages.

If there is a permanent low-level signal at PIN 4, this indicates an error.

Triggering the control signal at PIN 2 starts a self-test in the drive unit. If the self-test is successful, the drive unit switches to a high-level signal at PIN 4.

Depending on the version, the error message disappears from the display. If the self-test is not successful, a low level is still present at PIN 4 (error E4) and an error message appears on the display.

A possible control signal can be sent from the external controller (PLC)

at the earliest 3 seconds after the high level is present again as an output signal

at PIN 4. The drive unit does not process any control signals in the meantime.

The 14 seconds control signal is the only control signal that can be processed when a low level is sent as an output signal. A new control signal can be sent by the controller (PLC) at the earliest 3 seconds after a high-level signal is received at PIN 4.

It is essential that you determine and eliminate the cause of the error before acknowledging.

Please refer to the diagram below for a visual representation:

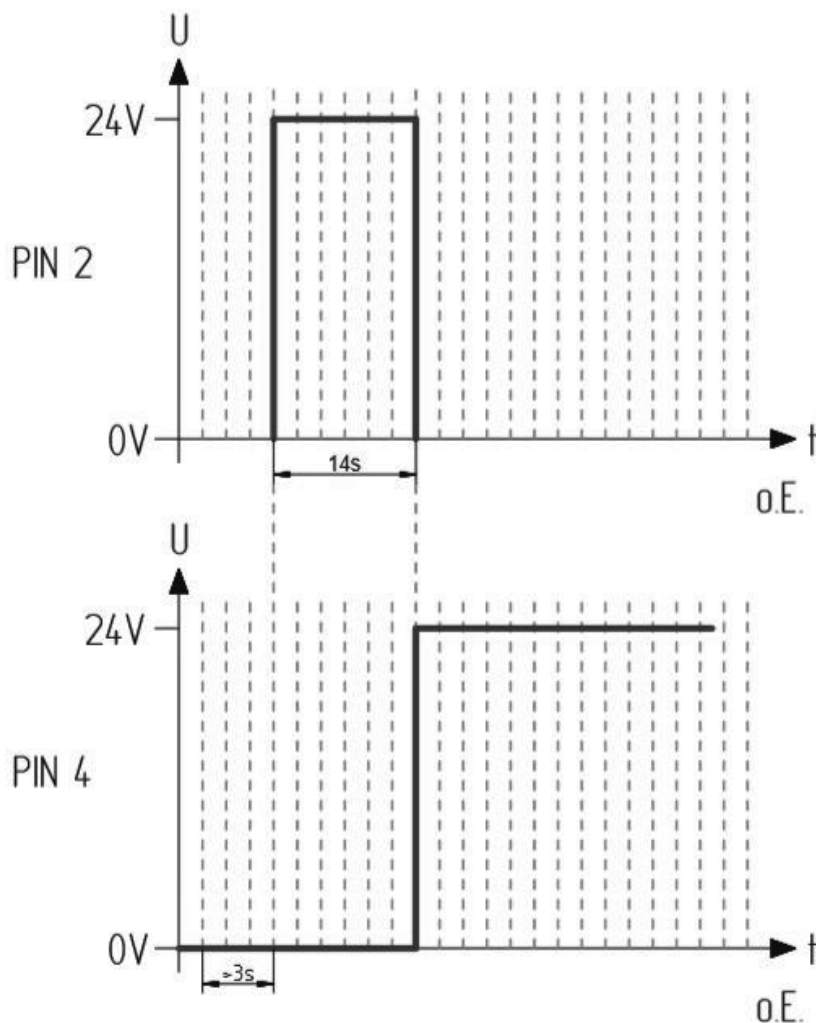

## 8. Error messages (troubleshooting)

	<b>⚠ WARNING</b>
	<p>Troubleshooting                  Can cause serious or fatal injuries</p> <ul style="list-style-type: none"> <li>▪ Observe the general, overarching residual hazards</li> <li>▪ Any work on the gear unit may only be performed when the gear is inactive</li> <li>▪ Do not switch off / disable any monitoring or protective devices</li> <li>▪ Secure the system against unintentional restart</li> </ul>

### 8.1 Error messages

Please note that all the following chapters presuppose a lubricant cartridge installed on the drive unit. The microelectronics integrated into the drive unit permanently monitor the status. In case of abnormalities, an addressed error message is shown on the display and/or output via PIN 4, depending on the version. There are differences here between the drive units, depending on the version selected.

Battery operation (version B):

- An error message is shown on the display here

External power supply (version V):

- Here a low-level signal is output at PIN 4 in addition to the visual display

External power supply (version D):

- Here a low-level signal is output at PIN 4.

LCD	Designation	Output signal (PIN4)
OFF	Switched off	Low, permanent
PUL	Ready for operation	High, permanent
PUL blinkend	Receive control signal	High, permanent
01...70	Donation process	Low, 7...17 Sekunden
E1	Empty cartridge	0.5Hz square wave signal in pulse mode, Low permanent
E2	Overload	Low, permanent
E3	Undervoltage / Battery Empty	Low, permanent
E4	Serious mistake	Low, permanent

	<b>NOTICE</b>
	<p>Maintenance / repair</p> <ul style="list-style-type: none"> <li>• Can lead to property damage or consequential damage</li> <li>▪ The lubricant cartridge size and the suitability of the lubricant does not take place</li> <li>▪ Opened lubricant cartridges must not be reused.</li> </ul>

### 8.1.1 Error E1 (empty signal)

The drive unit is equipped with a sensor system that detects when the lubricant cartridge is empty. After reaching the empty level, the drive unit no longer delivers lubricant. This ensures that no air gets into the drive unit or the lubricant lines. The empty level message is transmitted to the external controller (PLC). A separate and unique output signal is provided for this purpose that can be recognised easily and reliably by the external controller (PLC). There are differences here between the versions of the drive units.

#### Battery operation (version B):

- The error is indicated visually on the display.

#### External power supply (version V):

- The error is indicated visually on the display. In addition, a permanent 0.5 Hz low-level square-wave signal is sent to PIN 4.

#### External power supply PLC (version D):

- A permanent 0.5 Hz low-level square-wave signal is sent to PIN 4.

#### Remedy:

- Replacing/changing the lubricant cartridge automatically acknowledges the error and a permanent high-level signal is present at PIN 4.

Refer to the separate instructions for changing and screwing on the lubricant cartridge.

Please note that the signal at PIN 4 is switched to a permanent low-level signal when the lubricant cartridge is removed on versions with external power supply (version V / D).

Please refer to the diagram below for a visual representation:

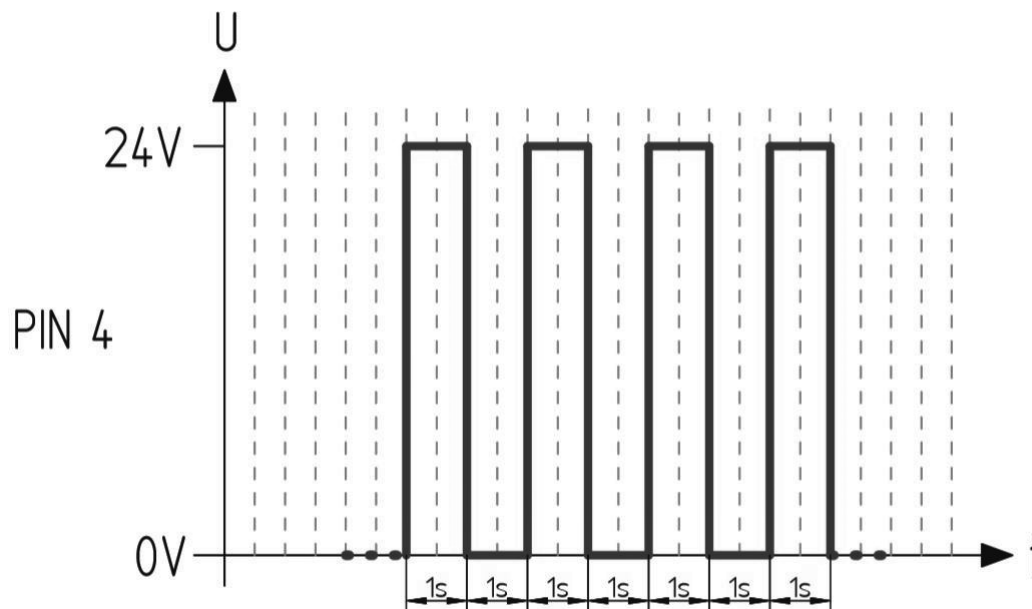

### **8.1.2 Error E2 (overload)**

Error E2 signals that the maximum permissible hydraulic back-pressure has been exceeded during a dispensing process.

There are differences here between the drive units, depending on the version selected.

#### **Battery operation (version B):**

- The error is indicated visually on the display.

#### **External power supply (version V):**

- The error is indicated visually on the display; in addition, a permanent low-level signal is output at PIN 4.

The microcontroller processes no more signals until the error has been eliminated.

#### **External power supply (version D)**

- The error is indicated by a permanent low-level signal at PIN 4.

The microcontroller processes no more signals until the error has been eliminated.

#### **Remedy:**

Eliminate all errors, check all hoses, distributors, lubrication points and components used for continuity before acknowledging the error.

**To acknowledge an error on the drive unit, proceed as follows, depending on the selected version and setting.**

#### **Battery operation (version B) and external power supply (version V) in hour mode (-h-) or emptying time mode (-Et-):**

- To do this, the drive unit must be switched off (OFF) and on again (ON).

#### **External power supply (version V in pulse mode / version D):**

- Here the error E2 can be acknowledged with a 14 seconds control signal.

### **8.1.3 Error E3 (undervoltage)**

Error E3 signals that the voltage supply is below the prescribed values for the drive unit or that the battery is empty.

There are differences here between the drive units, depending on the version selected.

#### **Battery operation (version B):**

- The error is indicated visually on the display.

#### **External power supply (version V):**

- The error is indicated visually on the display; in addition, a permanent low-level signal is output at PIN 4.

#### **External power supply (version D):**

- The error is indicated by a permanent low-level signal at PIN 4.

The microcontroller processes no more signals until the error has been eliminated.

#### **Remedy:**

#### **Battery operation (version B):**

- Switch off the drive unit (OFF), replace the battery and lubricant cartridge with new, unused ones and reactivate the drive unit (ON).

#### **External power supply (version V):**

- Switch off the drive unit (OFF); check the wiring and supply voltage and correct, if necessary. Reactivate the drive unit (ON).

#### **External power supply (version V in pulse mode / version D)**

- Check the wiring and supply voltage and correct, if necessary.

- Here the error can be acknowledged with a 14 seconds control signal.

### **8.1.4 Error E4 (serious error)**

Error E4 signals that the microcontroller has detected a serious error. The cause here can be mechanical, electronic or due to another influencing variable.

#### **Battery operation (version B):**

- The error is indicated visually on the display

#### **External power supply (version V / D):**

- The error is indicated by a permanent low-level signal at PIN 4; in addition, the error is indicated visually on the display with version V.

#### **Remedy:**

- The error cannot be acknowledged and rectified locally.

- Replace the drive unit together with the lubricant cartridge and send us the removed drive unit and lubricant cartridge as described in chapter "Repair".



## 9. Maintenance

### 9.1 Maintenance intervals

Before starting any (maintenance) work, read the general safety instructions (see chapter 2) and observe the relevant local and company safety regulations.

Do not disable any protective device!

**The following maintenance work must be carried out:**

Regular visual inspection of the drive unit and lubricant cartridge for possible error messages. Remedy the causes accordingly. Check the connected accessories for externally visible damage (e.g. loose or detached lines).

**Every 500 hours or every 3 months at the latest:**

Visual inspection and cleaning of the drive unit and lubricant cartridge as well as the accessories connected to it.

**Annual maintenance:**

We recommend replacing the lubricant cartridges annually to counteract possible segregation of the lubricant. The lubricant cartridge should be replaced after 2 years at the latest.

### 9.2 Cleaning

<b>NOTICE</b>	<b>NOTICE</b>
	<p>Cleaning May result in possible damage to property</p> <ul style="list-style-type: none"> <li>▪ Cleaning with compressed air or high-pressure cleaners is not permitted, this leads to damage to individual components and their premature failure.</li> <li>▪ Cleaning with any aggressive solvents/cleaning is not permitted.</li> </ul>

Only use suitable cleaning agents such as absorbent cloths and rags to clean the drive unit and lubricant cartridge. Do not use aggressive cleaners, they can attack plastics.

	<b>NOTICE</b>
	<p>Maintenance / repair</p> <ul style="list-style-type: none"> <li>- Can lead to property damage or consequential damage</li> <li>▪ Only use original lubricant cartridges with approved lubricants.</li> <li>▪ Ensure that only lubricant cartridges with the same filling and filling quantity is used</li> <li>▪ It is not possible to refill empty or opened lubricant cartridges.</li> <li>▪ Do not reuse opened lubricant cartridges.</li> </ul>

## **10. Replacing lubricant cartridge and battery**

Refer to the separate instructions (BKI 215) for changing and screwing on the lubricant cartridge.

The cartridge only needs to be replaced if it is empty or the lubricant has exceeded its service life. A cartridge can be changed during normal operation of the drive unit. In addition to changing the lubricant cartridge, we recommend changing the battery at the same time on the version for battery operation (version B).

Removing the empty battery (version B)

- Pull the empty battery out of the battery compartment. After completing the work, disconnect the polarised plug connection and dispose of the empty battery in accordance with your national regulations.

Inserting the new battery (version B)

- Connect the new battery to the battery cable with the polarised plug. Stow the battery and battery cable in the battery compartment. Ensure that the battery cable or plug does not protrude from the battery compartment.

Illustrations can be found under "Assembly" and "Installation".

If error E1 is shown on the display of the drive unit, the display goes out. Separate acknowledgement is not necessary.

If the cartridge runs empty (error E1) during a dispensing cycle, the cycle is automatically interrupted and is continued automatically after completion of the work.

If the drive unit (version B) has shown error E3 on the display, this must be rectified as described under error E3.

## **11. Repair**

If you send us the drive unit for repair, please send us a brief e-mail in advance

to [info@atlantagmbh.de](mailto:info@atlantagmbh.de) or call us at +49 (0)7142-7001-0 to discuss what further steps need to be taken.

Please ensure that all those involved are protected against harmful effects due to residues of hazardous substances on returned parts.

Affected products which have been contaminated with hazardous substances may only be returned to us after prior consultation and by complying with all applicable regulations.

The sender shall be liable for damage or injury resulting from failure to observe the legal regulations or resulting from false or undisclosed information.

We require the following information in advance:

- nameplate data (all details)
- type of malfunction (description)
- digital photos (if possible)

Shipping address for repair  
ATLANTA Antriebssysteme GmbH  
Adolf-Heim-Straße 16  
74321 Bietigheim-Bissingen  
Germany

## **12. Disposal**

Please observe the current national regulations!

If applicable, dispose of individual parts separately depending on their composition and existing country-specific provisions, e.g. as:

Metal scrap

- Attachment parts
- Reducing pieces / axles

Distributors

Plastic scrap

- Plastic housing
- Hoses

Batteries

Greases / oils (dispose of them as intended)

Operating materials contaminated by lubricants

13. Variants

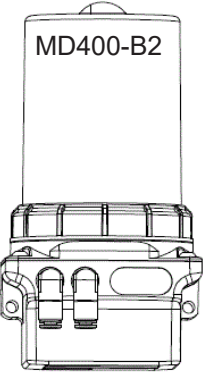
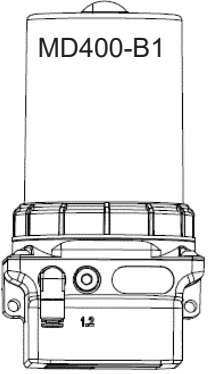
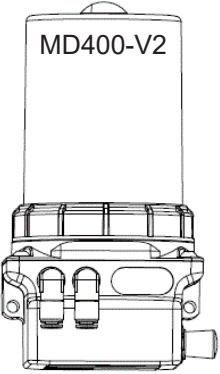
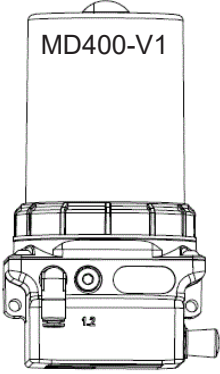
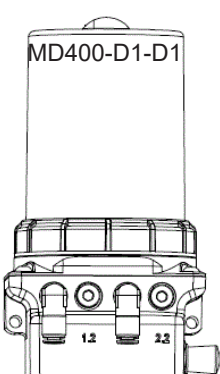
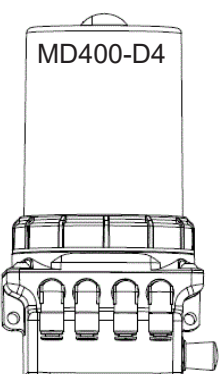
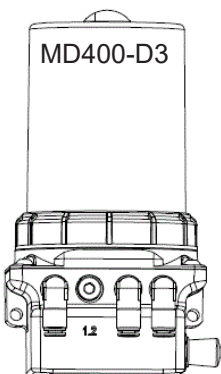
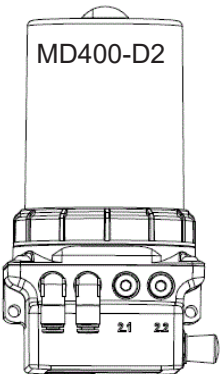
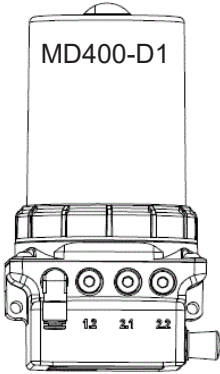

Quantity pumps	2
Dosing volume differences per pump	yes

Quantity pumps	1
Dosing volume differences per pump	inapplicable

## 14. Declaration of incorporation

Translation of original EC declaration of incorporation  
In terms of the EC Machinery Directive 2006/42/EC, annex II B

Manufacture / distributor:  
ATLANTA Antriebssysteme  
E. Seidenspinner GmbH & Co. KG  
Carl-Benz-Str. 16  
74321 Bietigheim-Bissingen

Contact:  
Tel./Fon: +49 (0) 7142-7001-0  
Fax: +49 (0) 7142-7001-99  
Email: info@atlantagmbh.de  
Web: www.atlantagmbh.de

We hereby declare that the incomplete machine

Product: MD400-B / MD400-V / MD400-D

Typ: 65 70 - 061/062 - 071/072 - 081/082/083/084/085

Serial number: According to type plate

complies with the essential requirements of the Machinery Directive 2006/42/EC applicable to partly completed machinery.

Furthermore, we declare that the special technical documentation for this partly completed machinery has been drawn up in accordance with Annex VII, Part B, and we undertake to submit it to the market surveillance authorities upon justified request.

The following harmonised standards have been applied:  
EN 12100:2011 Safety of machinery  
EN 61000-6-2, EN 61000-6-4 Electromagnetic compatibility (EMC)

The partly completed machine continues to comply with the regulations for Electromagnetic compatibility according to EC Directive 2004/108/EC

Commissioning of the partly completed machinery is prohibited until the partly completed machinery has been incorporated into a machine which complies with the provisions of EC Machinery Directive 2006/42/EC Annex II A.

Authorised to compile the technical documentation:



Björn Büchel  
(Engineering Director)

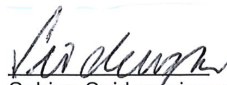

Sabine Seidenspinner  
(Managing Director)

Bietigheim-Bissingen den 22.02.2021

ATLANTA Antriebssysteme GmbH  
Adolf-Heim-Str.16  
74321 Bietigheim-Bissingen

Tel./Fon: +49 (0) 7142-7001-0  
Fax: +49 (0) 7142-7001-99  
Email: [info@atlantagmbh.de](mailto:info@atlantagmbh.de)  
Web: [www.atlantagmbh.de](http://www.atlantagmbh.de)

