



**ATLANTA**  
Antriebssysteme

**E-Servo-Worm Gear Unit  
Series 59**





# ATLANTA

## Installation and Maintenance Instructions

### BWS 110 (EN)

### 4100-001-12.93

Abteilung	4100
Änd. Index	J / 38012
Datum	23.03.22

**Series 59 E-Servo Worm-Gear Units**  
Translation from the German original

Seite	2	28
Name	Timmermann	24.06.2003
freigegeben		

### Contents

Company address .....	3
Who should study these instructions? .....	3
Safety notes .....	3
Naming .....	4
Exclusion of liability .....	4
Modifications, conversions .....	4
EC Machinery Directive .....	4
Technical changes .....	4
Risk analysis .....	4
Proper use .....	5
Improper use .....	6
Qualified personnel .....	6
General safety instructions .....	6
Short description .....	7
Item number .....	8
Identification .....	9
Tightening torques .....	9
Check list - start-up .....	11
Start-up / operation .....	12
Maintenance .....	12
Shaft sealing rings .....	13
Maintenance intervals .....	13
Changing the gear oil .....	14
Cleaning .....	15
Mounting instruction .....	16
Preparing the installation .....	16
Installation of worm-gear units .....	16
Mounting the output drive shaft (Version with shrink-disc) .....	17
Mounting the output-drive pinion shaft (Version with key) .....	19
Mounting the motor flange .....	20
Mounting the coupling on the motor shaft .....	20
Mounting the motor .....	22
Transport and handling .....	24
Storage .....	24
List of problems (Troubleshooting) .....	25
Disposal .....	26



**CAUTION!** The observance of these operation and maintenance instructions is prerequisite for the undisturbed operation and the acceptance of liability for possible defects. Therefore study the operation and maintenance instructions before starting to use the gear unit. Make sure that the operation and maintenance instructions are made accessible to the assembly personnel in legible condition. Observe any national / regional regulations concerning safety and prevention of accidents.



# ATLANTA

## Installation and Maintenance Instructions

### BWS 110 (EN)

### 4100-001-12.93

Abteilung	4100
Änd. Index	J / 38012
Datum	23.03.22

**Series 59 E-Servo Worm-Gear Units**  
Translation from the German original

Seite	3	28
Name	Timmermann	24.06.2003
freigegeben		

### Company address

ATLANTA Antriebssysteme GmbH  
Adolf-Heim-Str. 16  
74321 Bietigheim-Bissingen

Phone  
Telefax  
E-Mail  
Internet

0049(0)7142-7001-0  
0049(0)7142-7001-99  
info@atlantagmbh.de  
<http://www.atlantagmbh.de>

### Who should study these instructions?

These instructions are addressed to all persons installing, operating or maintaining the Series 59 E-Servo Worm-Gear Units.

You must not use the Series 59 E-Servo Worm-Gear Units before having read and understood these operating and maintenance instructions. Please give the safety instructions also to other persons.

### Safety notes

The following signal symbols and words are used in the instructions to warn you and/or inform you of something.

symbol	meaning
--------	---------



warns you about high injury hazards



warns you about possible injury hazards



warns you about minor injury hazards and/or damage hazards



**Environmentally hazardous** - warns you about a pollution hazard for the environment





by an "instruction to act" you are asked to do something



by a „hint“ you are informed of a possible simplification or improvement



When operated in  areas with explosion hazard the instructions identified by the  symbol are to be observed. These were prepared on the basis of the ignition danger rating KGA 114.



# ATLANTA

## Installation and Maintenance Instructions

### BWS 110 (EN)

### 4100-001-12.93

Abteilung	4100
Änd. Index	J / 38012
Datum	23.03.22

**Series 59 E-Servo Worm-Gear Units**  
Translation from the German original

Seite	4	28
Name	Timmermann	24.06.2003
freigegeben		

### Naming

The Atlanta Series 59 E-Servo Worm-Gear Unit are called Gear unit in this instruction

### Exclusion of liability

The manufacturer will not assume any liability for damage or injuries resulting from improper use of the Gear Unit.

Any improper manipulations and other acts not in accordance with these instructions may impair the quality of the product. This will lead to the loss of warranty claim for material defects against the company ATLANTA Antriebssysteme GmbH.

### Modifications, conversions

Modifications and/or conversions of the Gear unit are not permissible unless expressly approved by ATLANTA ATLANTA Antriebssysteme GmbH in writing.

### EC Machinery Directive

As defined by the EC Machinery Directive 2006/42/EG the Gear unit is not considered an autonomous machine but a component to be installed in machines.

Within the purview of the EC directive the unit must not be operated unless the machine into which this product is installed fulfills the requirements of the directive.

### Technical changes

ATLANTA ATLANTA Antriebssysteme GmbH reserve the right to make technical changes to improve the product.

### Risk analysis

We strongly recommend an analysis of the hazards emanating from the whole machine or plant.



# ATLANTA

## Installation and Maintenance Instructions

### BWS 110 (EN)

### 4100-001-12.93

Abteilung	4100
Änd. Index	J / 38012
Datum	23.03.22

**Series 59 E-Servo Worm-Gear Units**  
Translation from the German original

Seite	5	28
Name	Timmermann	24.06.2003
freigegeben		

### Proper use



The Gear unit may only be used for speed and torque conversion in machines and mechanical equipment under atmospheric pressure conditions. It must not be used outdoors. The permissible input speed and output torque as well as the permissible additional loads must not be exceeded. The layout instructions in the Atlanta catalogue must be observed. The maximum torques permitted are listed in our catalogue or our website:

<http://www.atlantagmbh.de>



The gearbox must not be used in combination with combustion engines – danger of overheating, inadmissible shock loading



The gear unit is not self-braking.



The Gear unit must not be used outdoors or under water.





The Gear unit depending on size is design for max. inputspeed of 5000min<sup>-1</sup> on the inputshaft. The input over the output shaft is not permissible without the manufacturer's written approval.

- The gear unit is designed for intermittent operation (**S3** acc. to DIN EN 60034-1).
- Continuous operation (**S1** acc. to DIN EN 60034-1) is not permissible without the manufacturer's written approval. Continuous operation is defined by the duty cycle. If it exceeds 30% or is longer than 20 minutes, it is considered continuous operation.



The surface temperature of the gearbox must not exceed 80° C during operation. When used in areas with  explosion hazard the temperature of the housing must not exceed 65°C.

-  If necessary, measure the surface temperature and warn or switch off when it exceeds 65°C
-  When used in areas with explosion hazard the instructions identified by the  symbol are to be observed.



# ATLANTA

## Installation and Maintenance Instructions

### BWS 110 (EN)

### 4100-001-12.93

Abteilung	4100
Änd. Index	J / 38012
Datum	23.03.22

**Series 59 E-Servo Worm-Gear Units**  
Translation from the German original

Seite	6	28
Name	Timmermann	24.06.2003
freigegeben		

### Improper use

Whenever the above mentioned limits are exceeded (especially higher torque or speed), this shall be considered improper use which is forbidden.

It is forbidden to operate the gear unit if:

- it is not correctly mounted (e.g. fastening of the motor),
- it is not properly installed (e.g. fixing screws),
- the gear unit is dirty,
- there is no sufficient lubrication.

### Qualified personnel

Some residual danger for persons and objects may emanate from the Gear unit. Therefore only skilled and trained personnel being aware of the possible risks may carry out mounting, installation, start-up, service, and maintenance work.

The personnel must have the necessary qualification for the work to be done and must be familiar with mounting, installation, starting up and operating the product. In addition they must carefully read, understand and observe the operating instruction and, in particular, the safety instructions.

The following works should also be carried out only by qualified personnel:

Transport, storage, erection/installation, connection, start-up, service, maintenance

### General safety instructions

We do not claim these safety instructions to be complete. In case of questions or problems please contact ATLANTA Antriebssysteme GmbH.

The gear unit incorporates the latest technological development at the time of delivery and can be principally regarded as safe to operate.



Improper manipulations may lead to injuries and damages.

- ☞ Make sure that the gear unit is only installed, serviced, or disassembled by specially trained skilled personnel.



Foreign matter flung about may cause serious injuries.

- ☞ Make sure that no foreign matter or tools are near the gear unit before starting operation.



Contact with hot surfaces may cause burns.

- ☞ Never touch gear units when they have high operating temperatures, or use suitable protective equipment (e.g. gloves).



# ATLANTA

## Installation and Maintenance Instructions

### BWS 110 (EN)

### 4100-001-12.93

Abteilung	4100
Änd. Index	J / 38012
Datum	23.03.22

**Series 59 E-Servo Worm-Gear Units**  
Translation from the German original

Seite	7	28
Name	Timmermann	24.06.2003
freigegeben		



Rotating parts may cause injuries. Pulling-in risk!

☞ Keep sufficient distance to rotating machine parts.



Never install or operate defective products.

☞ In case of damage please complain immediately.

### Short description

The Gear unit was developed for use with three-phase AC and DC servo motors. It features a low-clearance gearing. The light-metal casing ensures optimal heat dissipation. Robust bearings and an excellent stiffness permit the transmission of high torques and additional forces. The gear unit is supplied test-run, tightness-checked and thus ready for operation. The gear unit is available with different reduction ratios. Within one gearbox size and design all components, except for the set of wheels, are the same. The last 2 digits of the item number stand for the nominal reduction ratio. The exact reduction ratio can be seen from the table below.

Item no.	Actual gear reduction	Applicable to
xx xx x03	$18/6 = 3$	centre-distances 32, 50, 63, 80 mm
xx xx x05	$19/4 = 4.75$	all centre-distances
xx xx x07	$27/4 = 6.75$	all centre-distances
xx xx x09	$39/4 = 9.75$	all centre-distances
xx xx x15	$29/2 = 14.5$	all centre-distances
xx xx x20	$39/2 = 19.5$	all centre-distances
xx xx x29	$29/1 = 29.0$	all centre-distances
xx xx x39	$39/1 = 39.0$	all centre-distances
xx xx x50	$50/1 = 50.0$	centre-distances 32 and 50 mm
xx xx x52	$52/1 = 52.0$	centre-distances 63, 80 and 100 mm
xx xx x62	$62/1 = 62.0$	centre-distance 40mm

This gear unit is available with 2 output variations:

- hollow output shaft with key connection
- hollow output shaft for clamped connections



# ATLANTA

## Installation and Maintenance Instructions

### BWS 110 (EN)

### 4100-001-12.93

Abteilung	4100
Änd. Index	J / 38012
Datum	23.03.22

**Series 59 E-Servo Worm-Gear Units**  
Translation from the German original

Seite	8	28
Name	Timmermann	24.06.2003
freigegeben		

### Item number

The item number is composed as follows:

Example E servo worm-gear unit a=80mm, i=19.5 version with Iso connection

**59 0 5 0 20**

#### **Gear unit serie:**

- 98er (1arcmin)
- 58er (2arcmin)
- 59er (5arcmin)
- 57er (12arcmin)
- 51er (6arcmin)

#### **Ratio:**

- 3=3,00      5=4,75
- 7=6,75      9=9,25
- 15=14,5     20=19,5
- 29=29,00    39=39,00
- 50=50,00    51=51,00
- 52=52,00

#### **Special solution:**

- 0=Standard
- 1=Lebensmittelschmierung

- by 58 x7 - --
- 0 bzw. 1 =Flange size

#### **Hollow shaft:**

- 0= with key /( ISO connection by 98)
- 1= with Shrink disc

- by 58 x7 - --
- 4= Key way
- 8= with Shrink disc

#### **Center distance:**

- 1= 032 mm
- 2= 040 mm
- 3= 050 mm
- 4= 063 mm
- 5= 080 mm
- 6= 100 mm
- 7= 125 mm

#### **Construction-size:**

- 3= 050
- 4= 063
- 5= 080





# ATLANTA

## Installation and Maintenance Instructions

### BWS 110 (EN)

### 4100-001-12.93

Abteilung	4100
Änd. Index	J / 38012
Datum	23.03.22

**Series 59 E-Servo Worm-Gear Units**  
Translation from the German original

Seite	9	28
Name	Timmermann	24.06.2003
freigegeben		

### Identification

The gear unit is identified by a nameplate containing the gearbox type, the gear ratio, the max. speed for S3 operation, the assembly date, and the serial number of the gear unit



or



A separate oil rating plate specifies the type of oil:

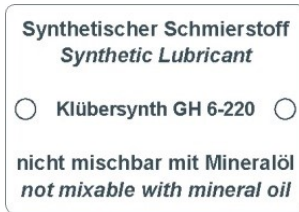

or for food-processing

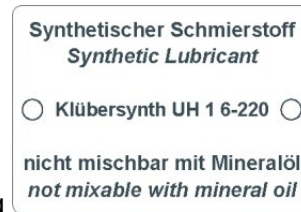

When used in areas with explosion hazard the gear unit must be adequately identified by a means of a nameplate. Only then it may be used in such areas:



or



Meaning of the designation:

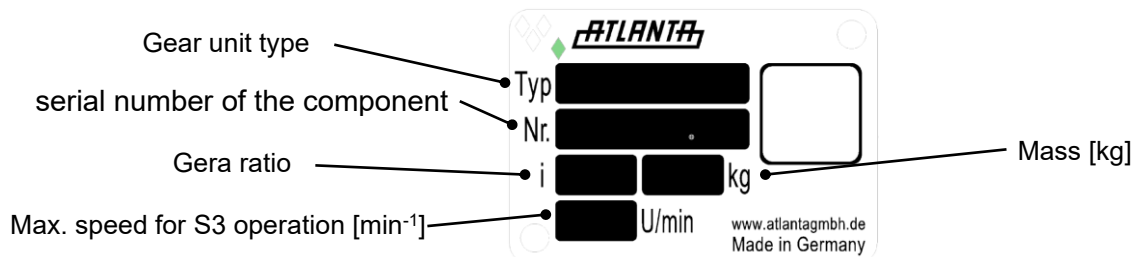



# ATLANTA

## Installation and Maintenance Instructions

### BWS 110 (EN)

### 4100-001-12.93

Abteilung	4100
Änd. Index	J / 38012
Datum	23.03.22

**Series 59 E-Servo Worm-Gear Units**  
Translation from the German original

Seite	10	28
Name	Timmermann	24.06.2003
freigegeben		

### Tightening torques

All screw connections for which tightening torques are specified are generally to be tightened and checked with a calibrated torque wrench. The tightening torque tables are contained in the relevant books. Should screws acc. to DIN EN ISO 4762 be employed, you can use the following table:

For the **countersunk holes**:



If you use an internal Standard to tighten the screws by using 90% of the strength of the screw than you have to use a suitable washer /sleeve

Hexag. socket-head screws DIN EN ISO 4762 Strength class 8.8 /aluminium housing	M5	M6	M8	M10	M12	M16
Tightening torque in Nm	5,6	9	21	42	49	125
Tightening torque in lbf in	50	81	186	371	433	1105

For the **threaded holes**:

(Effective length of thread min.  $1.5 \times d_{\text{enn}}$  / contact surface with at least  $500\text{N/mm}^2$  limiting surface pressure.)

Hexag. socket-head screws DIN EN ISO 4762 Strength class 8.8	M5	M6	M8	M10	M12	M16
Tightening torque in Nm	5,9	10	25	48	84	205
Tightening torque in lbf in	52	88	221	424	743	1813

<sup>\*)</sup> Use only calibrated torque wrenches! If the tightening torque is too low, the required torque will not be transmitted. If the tightening torque is too high, the screws will be overstrained and become unusable.



# ATLANTA

**Installation and  
Maintenance Instructions**

## BWS 110 (EN)

### 4100-001-12.93



Abteilung	4100
Änd. Index	J / 38012
Datum	23.03.22

**Series 59 E-Servo Worm-Gear Units**  
Translation from the German original

Seite	11	28
Name	Timmermann	24.06.2003
freigegeben		

### Check list - start-up

Before starting up

What has to be checked?	Checked
<b>Delivery:</b> <ul style="list-style-type: none"> <li>• Are the supplies in conformity with the consignment note?</li> <li>– Any transport damage should be reported immediately to the carrier.</li> <li>– Obvious defects / incompleteness should be reported immediately to ATLANTA Antriebssysteme GmbH.</li> </ul>	
 <b>Application in areas with explosion hazard:</b> <ul style="list-style-type: none"> <li>• Are the following data on the nameplate of the gearboxes/motors in conformity with the permissible „Ex“ application area on the site?</li> <li>– Explosion group</li> <li>– Category</li> <li>– Zone</li> <li>– Temperature class</li> <li>– max. surface temperature</li> </ul>	
<b>Ambient temperature:</b> <ul style="list-style-type: none"> <li>• Is the ambient temperature range acc. to the data on the lubricant table observed?</li> <li>– The max. ambient temperature of 40°C must not be exceeded throughout the whole operating time.</li> <li>– The temperature must not fall below the min. ambient temperature of -10°C throughout the whole operating time.</li> </ul>	
<b>Ventilation:</b> <ul style="list-style-type: none"> <li>• Is sufficient ventilation of the gearbox ensured?</li> </ul>	
 <b>Input and output drive elements:</b> <ul style="list-style-type: none"> <li>• Are all input and output drive elements to be mounted suitable for the specific „ex“ protection use?</li> </ul>	
<b>Nameplate information:</b> <ul style="list-style-type: none"> <li>• Are the data on the gearbox nameplate not exceeded?</li> </ul>	

During start-up

What has to be checked?	Checked
<b>Environment:</b> <ul style="list-style-type: none"> <li>• It must be ensured that there are no atmospheres, oils, acids, gases, vapours, or combustible dusts around which may explode!</li> </ul>	
<b>Temperature measurement:</b> The temperature <b>must</b> be measured after 3 hours of operation under max. operating load conditions! <ul style="list-style-type: none"> <li>• The temperature measurements shall be taken in the input area in places which are protected from the cooling air current. It is advisable to measure in various places in order to determine the maximum.</li> <li>• The absolute temperature of 80°C on the surface of the gearbox must not be exceeded so that the thermal stress on shaft seals and lubricants is kept low; this has a positive influence upon the service life.</li> </ul>	



# ATLANTA

## Installation and Maintenance Instructions



### BWS 110 (EN)

### 4100-001-12.93

Abteilung	4100	<b>Series 59 E-Servo Worm-Gear Units</b> Translation from the German original	Seite	12	28
Änd. Index	J / 38012		Name	Timmermann	24.06.2003
Datum	23.03.22		freigegeben		

### Start-up / operation

Make sure that the following preconditions for the operation are fulfilled:

- The control and protective systems must not be shut off. This applies also for trial runs and start-up operation.
- The gear units must not be operated under the following ambient conditions:
  - Explosive atmosphere, (Exception CE  II 3 G T4 / II 3 D T 130° C)
  - oils,
  - acids,
  - gases, (Exception CE  II 3 G T4 / II 3 D T 130° C)
  - vapours,
  - radiation.
- Depending upon the lubricants used the ambient temperature must be between -10°C and +40°C. If the ambient temperatures lie outside the permissible range, get into contact with ATLANTA Antriebssysteme GmbH.
- The gear units must not be operated unless sufficient ventilation is ensured in order to avoid any accumulation of heat.

 When used in areas with explosion hazard, the operator must ensure that the surface temperature of the gearbox does not exceed 65°C.; if necessary, control the surface temperature of the housing.



**CAUTION**

The surface of the gearbox can reach temperatures of more than 65°C. during operation and cause burns. The person installing the gear unit must take care that persons cannot be injured due to hot surfaces.



**DANGER**

Rotating parts can catch pieces of clothing, hair, and members of the body and injure persons. The person installing the gear unit must take care that persons cannot be injured rotating parts.

### Maintenance

**DANGER**

Accidental starting of the gear unit while maintenance work is being carried out can lead to serious accidents.

☞ Make sure that nobody can start the gear unit, while maintenance work is being performed.

**DANGER**

Even short operation of the gear unit while maintenance work is being carried out can cause accidents, if the safety devices are shut off and inoperative.

☞ Make sure that all safety devices are mounted and operative.



# ATLANTA

## Installation and Maintenance Instructions

### BWS 110 (EN)

### 4100-001-12.93

Abteilung	4100
Änd. Index	J / 38012
Datum	23.03.22

**Series 59 E-Servo Worm-Gear Units**  
Translation from the German original

Seite	13	28
Name	Timmermann	24.06.2003
freigegeben		

### Shaft sealing rings

Shaft sealing rings seal the gap between the housing and the rotating shafts. They are wearing parts which have to be replaced when they reach the permissible limit of wear.

The service life of shaft sealing rings is influenced by a multitude of parameters.

These are among others:

- peripheral speed at the sealing lip
- temperature
- internal pressure in the gearbox
- viscosity of the lubricant
- chemical analysis and additivation of lubricants
- mounting situation (lubricant supply to the sealing lip)
- particles and/or metallic fines in the lubricant
- material of the shaft sealing ring
- external pollution
- damage incurred during replacement

This multitude of influencing parameters make it practically impossible to predict the precise service life without making experiments simulating the respective application. As the service life of the shaft sealing rings is subject to the above mentioned fluctuations, it is absolutely necessary to check them at regular intervals. Only regular checks can prevent unnoticed loss of lubricant in the gearbox.

Whenever the shaft sealing is replaced you should also check the running surface of the lips of the seal on the shaft. If seizure marks are visible, the shaft must be repaired or replaced. Alternatively it is possible to insert the shaft sealing ring in a position somewhat axially displaced so that the lip of the seal runs in a practically new position.

### Maintenance intervals

Provided that the gear units are used properly as described in the catalogue, the gear units are designed and built for 12,000 h of operation except for wearing parts such as the bearings and the shaft sealing rings.

The following maintenance works should be performed for the gear units.

Interval	What should be done?
Every 2000 machine hours, but at least every six months	<ul style="list-style-type: none"> <li>• check the running noise to detect possible defects in the bearings</li> <li>• inspect the motor flanges for leakage</li> <li>• inspect the seals for leakage. Should any leakage be detected, please contact us.</li> </ul>



# ATLANTA

## Installation and Maintenance Instructions

### BWS 110 (EN)

### 4100-001-12.93

Abteilung	4100
Änd. Index	J / 38012
Datum	23.03.22

**Series 59 E-Servo Worm-Gear Units**  
Translation from the German original

Seite	14	28
Name	Timmermann	24.06.2003
freigegeben		

### Changing the gear oil

A sufficient amount of lubricant is absolutely necessary for safe operation. The lubricant ensures that dry running and consequently excessively high surface temperatures, wear (play), or mechanic sparking is prevented in the metallic contacts. The main danger is an unnoticed loss of lubricant. Therefore the gear units must be regularly checked for loss of lubricant.

ATLANTA E servo worm-gear units are filled with synthetic polyglycol oil.

Under the following preconditions this is a lifetime lubrication:

- The layout of the gear unit is strictly in accordance with the guidelines given in the ATLANTA catalogue ([www.atlantagmbh.de](http://www.atlantagmbh.de)).
- The gear unit is exclusively operated within the permissible characteristic and limit values ([www.atlantagmbh.de](http://www.atlantagmbh.de)).
- The operator checks the gear unit regularly (every 2 weeks) for loss of oil.
- The surface temperature must not exceed max. 80°C during operation.
- ☺ In the case of operation with mostly low input speeds (peripheral speed of the worm  $v < 0,5$  m/s) we recommend to change the lubricant every two years.

The gear unit is supplied filled with synthetic lubricant (viscosity class ISO VG 220). The type of lubricant filled in is indicated on the oil-rating plate.



For quantity of lubricant to be filled in see table below.

Synthetic oils are not miscible with mineral oils.

We recommend to use the following gearbox lubricants:

for general applications:

Manufacturer	Lubricant	Internet address
Klüber	Klübersynth GH6 – 220	<a href="http://www.klueber.de">www.klueber.de</a>

Order code for 1 liter of Klübersynth GH6-220: 65 90 010

for food-processing / pharmaceutical and ATEX applications:

Manufacturer	Lubricant	Internet address
Klüber	Klübersynth UH1 6 – 220	<a href="http://www.klueber.de">www.klueber.de</a>

Order code for 1 liter of Klübersynth UH1 6-220: on request

Gear unit centre distance	Oil quantity
32 mm	0.07 l
40 mm	0.15 l
50 mm	0.4 l
63 mm	0.7 l
80 mm	1.7 l
100 mm	2.0 l



# ATLANTA

## Installation and Maintenance Instructions

### BWS 110 (EN)

### 4100-001-12.93

Abteilung	4100
Änd. Index	J / 38012
Datum	23.03.22

**Series 59 E-Servo Worm-Gear Units**  
Translation from the German original

Seite	15	28
Name	Timmermann	24.06.2003
freigegeben		



**DANGER** Extended intensive contact with synthetic grease and synthetic oils can lead to skin irritation.

- ☞ Avoid extended contact with oils and/or grease and clean any oil-polluted patches of skin thoroughly.



**DANGER** Hot oil can scald you.

- ☞ Protect yourself against contact with hot oil when changing the oil.



**CAUTION** Blending different lubricants can deteriorate the lubrication characteristics. This may cause damage to the gear unit.

- ☞ Make a complete change of lubricant (including rinsing) when you wish to use another lubricant.



**CAUTION** Mineral oils reduce the transmission efficiency and must not be used without consulting ATLANTA.



Lubricants (oils and fats) are dangerous substances which may pollute soil and water

- ☞ Collect drained off lubricant in suitable containers and dispose of them in accordance with the applicable national regulations.
- ☞ Prevent lubricants from penetrating into drain pipes, the sewerage, and water.

### Cleaning

- ☞ Dust deposits of more than 5 mm thickness on the gearbox are not permissible because they increase the surface temperature which may result in the ignition of the dust.



**CAUTION** Cleaning with high-pressure cleaner is not permitted because it destroys the sealing rings so that water may penetrate into the gear unit causing premature failure of the gear unit.



**CAUTION** Cleaning with solvents is permissible only if these have been released by the company ATLANTA Antriebssysteme GmbH in writing.



# ATLANTA

## Installation and Maintenance Instructions

### BWS 110 (EN)

### 4100-001-12.93

Abteilung	4100
Änd. Index	J / 38012
Datum	23.03.22

**Series 59 E-Servo Worm-Gear Units**  
Translation from the German original

Seite	16	28
Name	Timmermann	24.06.2003
freigegeben		

### Mounting instruction



Mounting work may only be carried out by skilled or specially trained personnel.

### Preparing the installation

☞ Check the gear unit for damage or soiling on the outside.



A damaged or dirty gear unit must neither be installed nor operated.



The gear unit, especially the area of the seals, must not be cleaned with sharp-edged objects or cleansing liquids.



If the gear unit is cleaned in the area of the seals with a cleansing agent approved by ATLANTA Antriebssysteme GmbH, the cleaned surfaces must then be protected again against corrosion.

### Installation of worm-gear units

There are 5 machined mounting faces with sufficiently dimensioned pre-drilled fixing holes and tapped holes. It is important to ensure tension-free mounting. Use all fixing holes of the pertinent contact face. Hexagon nuts or screws are to be tightened to the specified torque and secured. The correct tightening torque can be seen from the respective tables. Special attention should be paid to the strength class of the screws and the material of the supporting surfaces.

- ☞ If the additional forces are to be fully used, the gear unit should be attached to the largest contact face, i.e. to one of the two lateral surfaces.
- ☞ Mounting the worm-shaft (input drive shaft) in a lateral and/or inferior position is ideal with a view to lubrication. Mounting the shaft in a top position will reduce the driving power by about 10%. Avoid to install the unit with the motor hanging downward. In this position leakage oil could get into the motor.

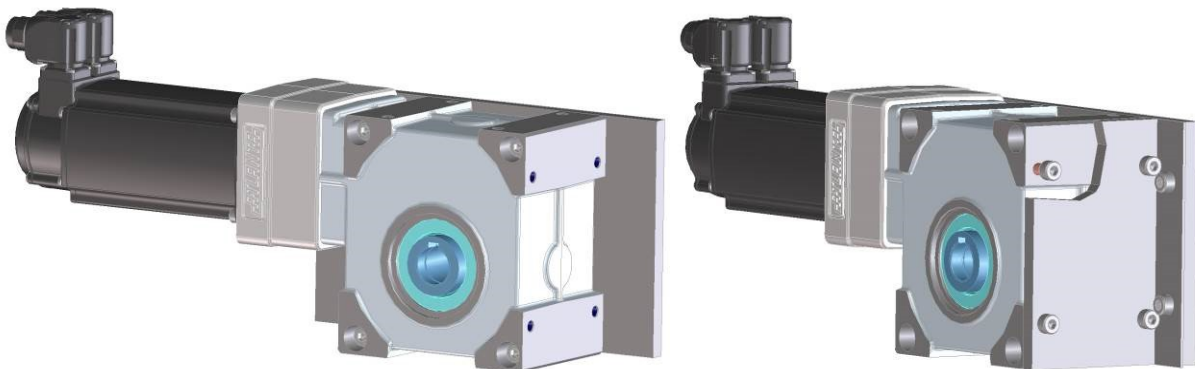





# ATLANTA

## Installation and Maintenance Instructions

### BWS 110 (EN)

### 4100-001-12.93

Abteilung	4100
Änd. Index	J / 38012
Datum	23.03.22

**Series 59 E-Servo Worm-Gear Units**  
Translation from the German original

Seite	17	28
Name	Timmermann	24.06.2003
freigegeben		

☞ For precise positioning and stability of the gear unit we recommend to provide an torque arm on the front face of the gearbox.

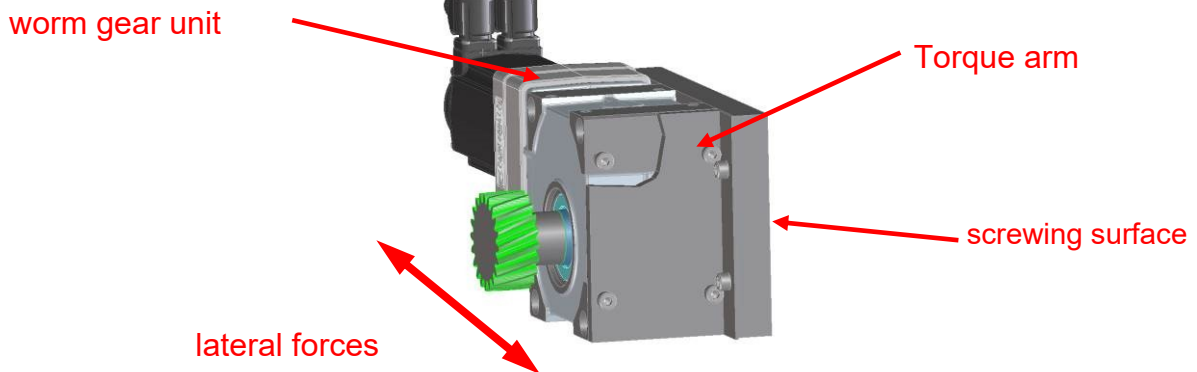

Any additional attachments and/or modifications of the gear unit are not permissible unless approved by ATLANTA in writing.



Do not use the gear unit at ambient temperatures of  $< -10\text{ °C}$  and  $> 40\text{ °C}$ .

- ⊗ The most suitable point for controlling the max. permissible surface temperature of the housing is in the area of the input-side worm-shaft bearing.
- ⊗ The vertical arrangement of the shaft (input or output vertically downward) is only permissible with an oil level monitor stopping the gear unit in case of a sudden loss of oil.

### Mounting the output drive shaft (Version with shrink-disc)

For the output drive shaft we recommend tolerance h6 (DIN ISO 286). The material must have a minimum yield point of  $385\text{ N/mm}^2$ .

If you have bought the output drive shaft from ATLANTA and if it is not supplied already mounted, we recommend to proceed as follows:

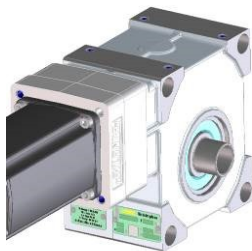

Gearbox without output shaft

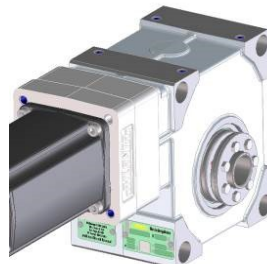

Gearbox with shrink-disc set

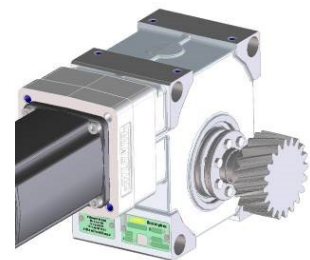

Gearbox with output shaft and shrink-disc set

- Clean the seat of the hollow shaft from grease, oil and contamination.
- Slide the shrink-disc onto the hollow shaft.
- ☺ Do not tighten the screws beforehand!



# ATLANTA

## Installation and Maintenance Instructions

### BWS 110 (EN)

### 4100-001-12.93

Abteilung	4100
Änd. Index	J / 38012
Datum	23.03.22

**Series 59 E-Servo Worm-Gear Units**  
Translation from the German original

Seite	18	28
Name	Timmermann	24.06.2003
freigegeben		

- Clean the output drive shaft from grease, oil and contamination
- Clean the hollow shaft from grease, oil and contamination
- Push the output drive shaft into the bore right up to the stop.
- Attach the shrink-disc by evenly tightening the screws one after the other (not crosswise !).
- ☺ Make sure that the two clamping discs are plane parallel.
- Several passes are necessary until the screws are tightened to the specified torque acc. to the table below.

Order code	Tightening torque *)
8081024	5 Nm
8083030	5 Nm
8084036	12 Nm
8085050	12 Nm
8086062	12 Nm

\*) Use only calibrated torque wrenches! If the tightening torque is too low, the required torque will not be transmitted. If the tightening torque is too high, the screws will be overstrained and become unusable.



Soiling may impede the transmission of the torque. Do not disassemble the shrink-disc clamping set before mounting it.



If the gear unit is cleaned in the sealing area with a cleansing agent approved by ATLANTA Antriebssysteme GmbH the surfaces cleaned must be protected again against corrosion.



The forces of the shrink-disc can deform the hollow shaft. Always install the machine shaft before tightening the clamping screws of the shrink-disc.



Slanting the shafts may cause damage. Make sure that the hollow shaft and the machine shaft are aligned.



Excessive screw tightening torque have the affect that the shrink-disc will be damaged



The screws must mounted one after the other, tightening crosswise have the effect that the shrink-disc will be damaged and to a reduced transmittable torque

⚠ When used in areas with explosion hazard the improper installation may lead to inadmissibly high temperatures. Check the tightening torques and axial fixing after 10 hours under operating conditions.



# ATLANTA

## Installation and Maintenance Instructions

### BWS 110 (EN)

### 4100-001-12.93

Abteilung	4100
Änd. Index	J / 38012
Datum	23.03.22

**Series 59 E-Servo Worm-Gear Units**  
Translation from the German original

Seite	19	28
Name	Timmermann	24.06.2003
freigegeben		

### Mounting the output-drive pinion shaft (Version with key)

Unless the output pinion shaft comes already fully assembled, we recommend to proceed as follows:

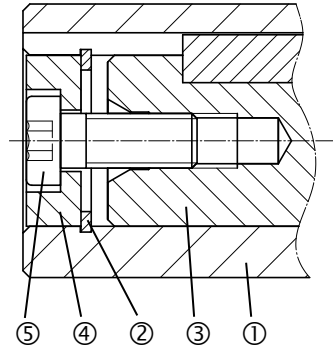

- Clean the seat of the hollow shaft ① and rub it in with MoS<sub>2</sub>-powder or grease (reduces fretting corrosion).
- Insert the retaining ring ② into the recess of the hollow shaft ①.
- Push in the output shaft ③ right up to the stop.
- Insert the retaining ring ④ from the opposite side up to the stop inside the hollow shaft ①.
- Connect the retaining ring ④ and the output shaft ③ by means of the screw ⑤.
- Secure the screw ⑤ using suitable adhesive (e.g. Loctite 243).

\*) Dry lubricant: Improves the sliding properties of machine parts and reduces friction and wear within a wide temperature range; minimum friction with maximum load capacity.

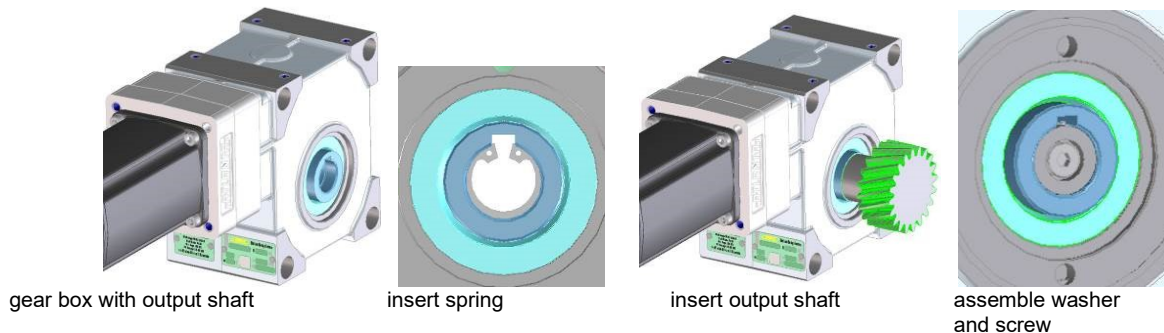

Hexagon socket head-screws DIN EN ISO 4762 strength rating 8.8 / retaining ring	M5	M8	M12	M16
Tightening torque in Nm	5,9	25	84	205
Tightening torque in lbf in	52	221	743	1813

**CAUTION** Slanting the shafts may cause damage. Make sure that the hollow shaft and the machine shaft are aligned. Mount the machine shaft in the hollow shaft without using force. Never try to mount it by means of knocking it in. Use only suitable tools and devices.

⚠ When used in areas with explosion hazard, improper installation may lead to inadmissibly high temperatures (see ignition danger rating acc. to KGA 114). Check the tightening torques and the axial fixing after 10 h work under operating conditions.



# ATLANTA

## Installation and Maintenance Instructions

### BWS 110 (EN)

### 4100-001-12.93

Abteilung	4100
Änd. Index	J / 38012
Datum	23.03.22

**Series 59 E-Servo Worm-Gear Units**  
Translation from the German original

Seite	20	28
Name	Timmermann	24.06.2003
freigegeben		

### Mounting the motor flange

Clean the contact surfaces of flange and gear unit. The flange could be mounted with a slight press fit to the gear unit .

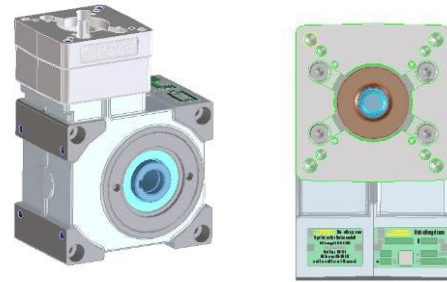
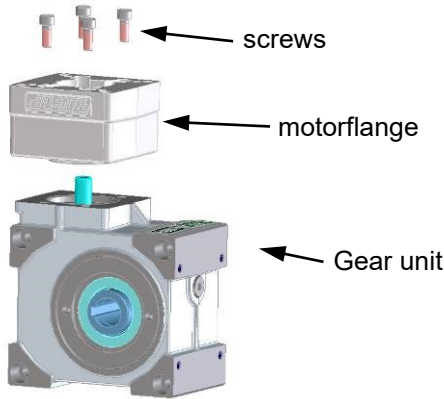

Screws should be tightend in severals steps across with defined torque according to table underneth.

Set motorflange to the gear unit and adjust both parts via screw holes and do a precentering. Insert the screws

Hexagon socket head-screws DIN EN ISO 4762 strength rating 8.8	centre distance					
	32mm	40mm	50mm	63mm	80mm	100mm
Screw size	M6	M6	M8	M8	M10	M10
Tightening torque in Nm <sup>*)</sup>	9	9	21	21	42	42
Tightening torque in lbf in <sup>*)</sup>	81	81	186	186	371	371

<sup>\*)</sup>Use only calibrated torque wrenches! If the tightening torque is too low, the required torque will not be transmitted. If the tightening torque is too high, the screws will be overstrained and become unusable.



# ATLANTA

## Installation and Maintenance Instructions

# BWS 110 (EN)

## 4100-001-12.93

Abteilung	4100
Änd. Index	J / 38012
Datum	23.03.22

**Series 59 E-Servo Worm-Gear Units**  
Translation from the German original

Seite	21	28
Name	Timmermann	24.06.2003
freigegeben		

### Mounting the coupling on the motor shaft

ATLANTA E servo special coupling 65 5X XXX or 65 4X XXX

The coupling is supplied pre-assembled.

- Before mounting the coupling on the motor shaft clean all contact surfaces and coat them with a thin oil film (no grease). Any excess oil should be wiped off with a rag.
- Rub the DIN 5480 profile of the coupling with MoS<sub>2</sub><sup>\*</sup> powder or grease (reduces fretting corrosion)
- If the motor shaft has a key, it should be removed.
- Slide the coupling onto the motor shaft as far as specified in the catalogue as „X1" (65 5X XXX) and/or right up to the stop (65 4X XXX / shoulder or retaining ring).
- In the case of coupling 65 5X XXX intermediate sleeves may be used in order to reach the motor-shaft diameter. In such a case the slot in the intermediate sleeve must be aligned with the slot in the coupling body.
- Slightly tighten the clamping screws.
- Tighten screws uniformly by turning them alternately (crosswise with 65 4X XXX).
- Check coupling for true running at the reference diameter ( $f_r < 0.04$  mm).
- Several passes are necessary until the screws are tightened to the tightening torque specified in the table below.
- Make sure that the width of the gap between coupling and pressure surface remains uniform.
- Check at reference diameter for true running.

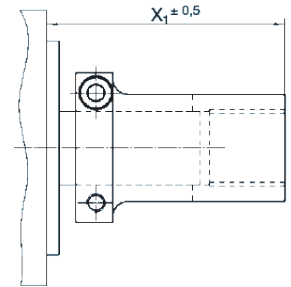

<sup>\*</sup>) Dry lubricant: Improves the sliding properties of machine parts and reduces friction and wear within a wide temperature range; minimum friction with maximum load capacity.



65 5X XXX

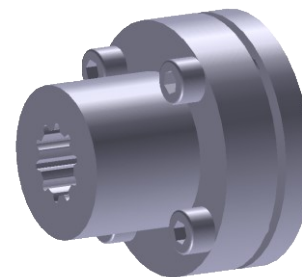

65 4X XXX

Bestell-Nr. der Kupplung	Anzugsmoment <sup>**</sup> )	
	Nm	lbf in
65 51 xxx	7 Nm	62 lbf in
65 53 019 - 024	12 Nm	106 lbf in
65 53 025 - 038	36 Nm	319 lbf in
65 54 009 - 024	12 Nm	106 lbf in
65 54 025 - 042	36 Nm	319 lbf in
65 55 014 - 020	25 Nm	221 lbf in
65 55 022 - 042	36 Nm	319 lbf in

Bestell-Nr. der Kupplung	Anzugsmoment <sup>**</sup> )	
	Nm	lbf in
65 43 xxx	7 Nm	62 lbf in
65 43 924	10 Nm	88,5 lbf in
65 44 xxx	10 Nm	88,5 lbf in
65 46 xxx	10 Nm	88,5 lbf in
65 47 xxx	25 Nm	221 lbf in

<sup>\*\*</sup>) Use only calibrated torque wrenches! If the tightening torque is too low, the required torque will not be transmitted. If the tightening torque is too high, the screws will be overstrained and become unusable.



# ATLANTA

## Installation and Maintenance Instructions

### BWS 110 (EN)

### 4100-001-12.93

Abteilung	4100	<b>Series 59 E-Servo Worm-Gear Units</b> Translation from the German original	Seite	22	28
Änd. Index	J / 38012		Name	Timmermann	24.06.2003
Datum	23.03.22		freigegeben		

- ⚠ When used in areas with explosion hazard, improper installation may lead to inadmissibly high temperatures (see ignition danger rating acc. to KGA 114). Check the tightening torques and the axial fixing after 10 hrs work under operating conditions.
- ⚠ When used in areas with explosion hazard, use corrosion-protected screws



Clean motor and coupling surfaces

Mount the coupling on the motor shaft and fasten as described

### Mounting the motor

- Before screwing on the motor, clean all contact surfaces.
- Slide the motor with coupling mounted onto the teeth of the input drive shaft and into the gear centering piece so that the plane surfaces touch.
- If necessary, rotate the motor around the motor axle until the coupling and the input shaft teeth mesh.
- 👉 The motor must slide on easily.
- 👉 There must not be any gap between the motor and the gearbox flange.
- ⚠ **CAUTION** Mounting motors having longer shafts than permissible for the respective gear unit leads to tensions which damage the motor and the gear unit. Check the interfering edges by measuring out or by checking the dimension according to our catalogue data and the motor manufacturer's data.
- Screw motor and gearbox together. Hexagon nuts or screws are to be tightened to the specified torque and secured. The correct tightening torque can be seen from the respective tables. In this context it is particularly important to pay special attention to the strength class of the screws and the material of the supporting surfaces.
- The motor can be mounted optimally centered by positioning the gearbox in such a way that the worm-shaft is standing up vertically.
- ☺ Use screws with an effective length of at least 1.6 x thread diameter.
- ⚠ When used in areas with explosion hazard, use corrosion-protected screws.



# ATLANTA

## Installation and Maintenance Instructions

### BWS 110 (EN)

### 4100-001-12.93

Abteilung	4100
Änd. Index	J / 38012
Datum	23.03.22

### Series 59 E-Servo Worm-Gear Units

Translation from the German original

Seite	23	28
Name	Timmermann	24.06.2003
freigegeben		

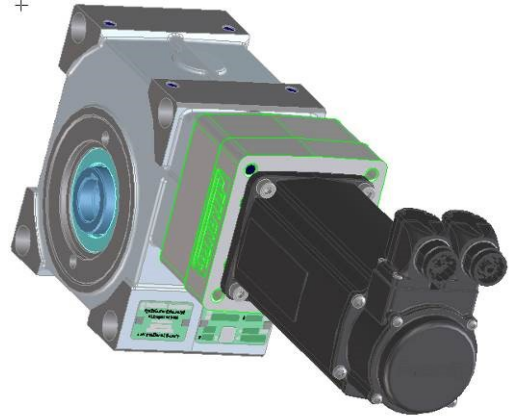
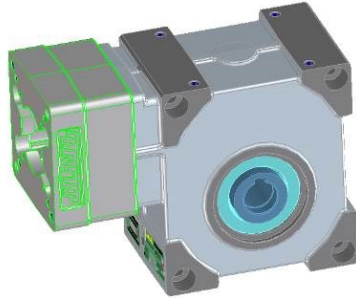

Clean screwing surfaces on motor and gearbox  
rub coupling profile with MoS<sub>2</sub><sup>\*)</sup> powder or grease

Screw motor to gearbox,  
ensure proper tightening torque

\*) Dry lubricant: Improves the sliding properties of machine parts and reduces friction and wear within a wide temperature range; minimum friction with maximum load capacity.



# ATLANTA

## Installation and Maintenance Instructions

# BWS 110 (EN)

## 4100-001-12.93

Abteilung	4100
Änd. Index	J / 38012
Datum	23.03.22

**Series 59 E-Servo Worm-Gear Units**  
Translation from the German original

Seite	24	28
Name	Timmermann	24.06.2003
freigegeben		

### Transport and handling

There are no special holes or threads provided for transporting and handling the gear unit. There are, however, numerous fixing threads available in the gear housing permitting to screw in eye-bolts so that it is possible to handle the gearbox safely.

- ☞ Observe all safety regulations in connection with transport and handling using lifting gear.
- ☞ Make sure that the load is handled and set down slowly and carefully.



It's forbidden to connect the lifting equipment on the flange.

Gearbox centre-distance	Weight of gearbox without attachments
32	≈ 2 kg
40	≈ 6 kg
50	≈ 6,5 kg
63	≈ 11,5 kg
80	≈ 22 kg
100	≈ 37 kg

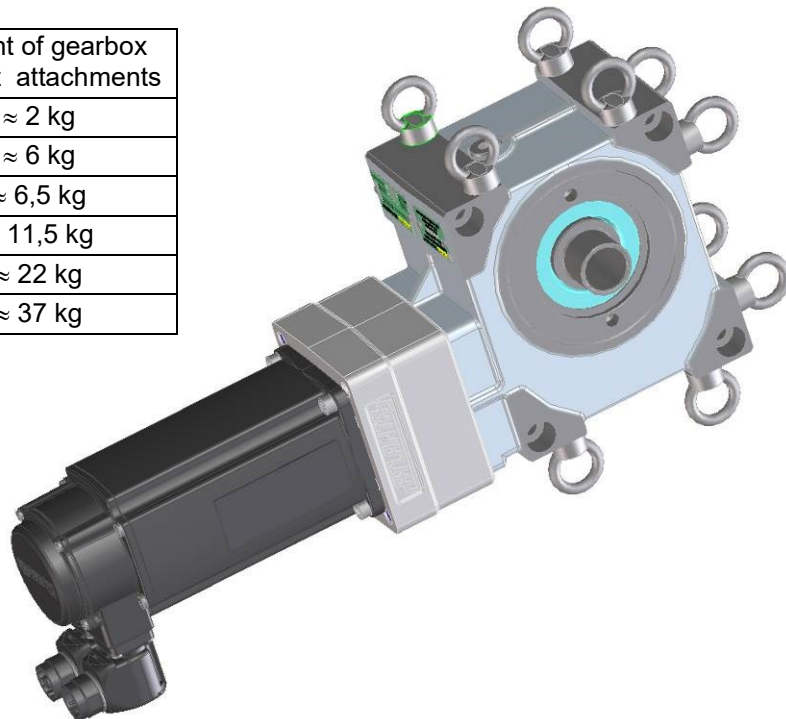

### Storage

If the gear unit is not installed immediately after its delivery, the following measures are to be taken:

- ☞ Store the gear unit with horizontal hollow output shaft and horizontal input drive shaft (worm shaft) on top in such a way that - except for the supporting surface - it cannot come into contact with any other objects.
- ☞ Protect the gear unit against environmental influences (ozone, UV light, electric welding, dust, dirt, moisture, temperature fluctuations [0°C to +30°C], shocks etc.).
- ☞ Connecting parts, e.g. coupling or output shaft, are to be stored separately.
- ☞ Protect the steel parts against corrosion.
- ☞ As logistics principle for store-keeping we recommend the „first in – first out“ principle.
- ☺ Occasionally turning the input shaft of the gear unit will facilitate the start-up
- ☞ The max. storage time under such conditions is 2 years.





# ATLANTA

## Installation and Maintenance Instructions

### BWS 110 (EN)

### 4100-001-12.93

Abteilung	4100
Änd. Index	J / 38012
Datum	23.03.22

**Series 59 E-Servo Worm-Gear Units**  
Translation from the German original

Seite	25	28
Name	Timmermann	24.06.2003
freigegeben		

### List of problems (Troubleshooting)

You should take remedial measures at once, if you get aware of oil loss, increased operating noises, or increased operating temperatures.

Any disturbances occurring during the warranty period requiring the repair of the gear unit, may only be remedied by ATLANTA.

We recommend to ask for our assistance also after the expiration of the warranty period.



Always shut down the gearbox during the removal of disturbances. Secure the driving unit against inadvertent starting. Post a notice at the switching position.

Problem	Possible cause	Remedy
Increased operating temperature	Layout too weak; Speed / torque too high	Check the technical data
	Motor heats up the gear unit	Check the attachment circuit, replace the motor, or provide an insulation between motor and gear unit
	Ambient temperature too high	Ensure adequate cooling
	Duty cycle too long	Verify the layout
Increased operating noise	Defective bearing	Please contact us
	Defective tooth system	
	The fixing of the gear unit has loosened.	Tighten screws/nuts with the specified tightening torque. Replace defective screws/ nuts.
Loss of oil	Adjustment of controller.	Check the servo-motor parameters
	Leakage	Get into contact with us.
	Apparent leakage	A temporary leakage due to much grease between sealing lip and protective lip . The surplus grease can penetrate outside as an apparent leakage.



# ATLANTA

## Installation and Maintenance Instructions

### BWS 110 (EN)

### 4100-001-12.93

Abteilung	4100
Änd. Index	J / 38012
Datum	23.03.22

**Series 59 E-Servo Worm-Gear Units**  
Translation from the German original

Seite	26	28
Name	Timmermann	24.06.2003
freigegeben		

### Disposal



Please observe the national regulations!

If required, dispose of the individual components separately depending on their nature and any existing specific national regulations, e.g. as:

- Steel scrap
  - gearwheels
  - shafts (hollow shafts)
  - antifriction bearings
  - cast iron parts
  - coupling
- Aluminium scrap
  - housing elements
  - adaptor elements
- Bronze scrap
  - worm-wheel (separated from hollow shaft)
- Collect waste oil and dispose of as directed.

**ATLANTA does not accept liability for any damage to the transmission or any consequential damage, if these instructions are not observed.**



**Atlanta Antriebssysteme GmbH**

Adolf-Heim-Str.16

D-74321 Bietigheim-Bissingen

Tel: +49 (0) 7142-7001-0

Fax: +49 (0) 7142-7001-99

Email: [info@atlantagmbh.de](mailto:info@atlantagmbh.de)

Web: [www.atlantagmbh.de](http://www.atlantagmbh.de)

